



DS-11 Series

Spectrophotometer / Fluorometer

User Guide



Table of Contents

1. Introduction	6
Product Technology	6
Upgrade Options	6
2. Set up and Safety	7
Cautions	7
Instrument Rear Panel	7
VCCI (Class B) compliance statement for users in Japan	8
3. Instrument Diagram	9
4. Software Quick Guides	10
EasyApps™ Software Icons	10
Software Buttons	11
Software Navigation	11
Top Bar Overflow Functions	12
5. Absorbance Run Screen	13
Run Screen	13
Microvolume Measurements	13
Cuvette Measurements	14
AutoRun	14
Measurement Modes	14
21 CFR Mode Measurements	15
6. Absorbance Report and Graph Screens	16
Report Screen	16
Graph Screen	16
7. Absorbance Best Practices	18
Best Practices for Absorbance Measurements	18
8. Tech Team Tips	19
Initialization	19
Connectivity and Results Data	19
Software Updates	19
Technical Support	19
9. Absorbance Nucleic Acid Apps	20
Quick Protocol	20
dsDNA, RNA and ssDNA	21
Microarray	22
Dye List	23
Baseline Correction for Dyes	24
Nucleic Acid Concentration Calculations	25
Purity Ratios	25
10. Absorbance Purified Protein, Peptide Apps	27
Quick Protocol	27

Protein A280.....	28
Protein Type List.....	28
Baseline Correction	29
Labeled Proteins.....	30
Protein Type List.....	30
Dye List.....	31
Peptides.....	31
Protein and Peptide Concentration Calculations	32
11. Absorbance Colorimetrics App-----	34
Quick Protocol	34
Generating a Standard Curve.....	34
Line Fit.....	36
Saving a Standard Curve	36
Editing a Standard Curve	36
Exporting a Standard Curve	37
BCA	38
Bradford.....	38
Lowry	38
Pierce 660	38
12. Absorbance UV-Vis App -----	39
Quick Protocol	39
Wavelength List.....	39
Wavelength Range Selection	39
Cursor Position	39
Baseline Correction	40
13. Absorbance OD 600 App-----	41
Quick Protocol	41
Unique Features.....	42
14. Absorbance Kinetics App -----	43
Quick Protocol	43
Define Method Screen Features.....	43
15. Absorbance Custom Methods Apps-----	47
Quick Protocol	47
Primary Settings	48
Custom Standard Curve Methods	48
Custom Formula Methods	49
Formula Guidelines	50
16. Fluorescence: Basic Operation-----	51
Fluorescence Measurements	51
Best Practices.....	51
17. Fluorescence: Standard Curve Method Apps -----	53
Quick Protocol	53

	Run Screen- Assay and Curve Selections	55
	Run Screen- Standard Curve View	56
18.	Basic Fluorometer App-----	59
	Quick Protocol	59
19.	Data Export and Print Options-----	61
	Export Options	61
	Export Via Email	61
	Export to a Network Folder	62
	USB	62
	Print Options.....	62
20.	Utility Apps and Functions-----	63
	User Accounts App.....	63
	Data App.....	65
	Exporting and Deleting Data.....	65
	Settings App	66
	Updater App	69
21.	21 CFR App-----	70
	Compliance Ready Software	70
	Activation Wizard Overview.....	71
	Activation Wizard 1/7 - Administrator Account	71
	Activation Wizard 2/7 – Enter Activation Code	71
	Activation Wizard 3/7 - Roles	71
	Activation Wizard 4/7 – Signature Meaning.....	72
	Activation Wizard 5/7 – Role-Signature Meaning Linking.....	72
	Activation Wizard 6/7 – Password Rules.....	73
	Activation Wizard 7/7 – Existing Users.....	73
	Measurements and Electronic Signed Records	74
	Audit Trail	75
	Archiving.....	76
22.	21 CFR Mode - Utility Apps and Functions-----	77
	User Accounts App.....	77
	Data App.....	79
	Settings App	80
	Updater App	80
23.	Lab Tool Apps-----	81
	Calculator App.....	81
	Timer App.....	82
	ScreenLocker	82
24.	Maintenance-----	83
	Cleaning	83
	Guidelines.....	83
	Cuvette and Fluorescence Mode Holder Cleaning.....	83

Solvent Compatibility	83
25. Diagnostics	84
DS-11 Self Test	84
Lamp Reset	84
Microvolume Pathlength Verification	84
Results.....	85
FX- Diagnostics	87
26. Troubleshooting	88
Quick Help	88
Software Errors.....	89
Printer and Barcode Scanner	89
27. Customer Support	90
Warranty	90
Disclaimer.....	90
Instructions for Disposal of Packaging and Waste Equipment	90
Research Use Only	90

1. Introduction

Product Technology

DeNovix Spectrophotometers / Fluorometers are compact, stand-alone instruments with a high-resolution touchscreen. EasyApps™ software utilizes application specific icons along with a custom operating system to provide an intuitive, easy-to-use instrument for both absorbance and fluorescence measurements.

SmartPath™ technology automatically adjusts the microvolume mode pathlengths to enable sample measurements across a broad concentration range. Bridge Testing™ verification identifies and adjusts in real-time for a broken sample column, ensuring accurate measurements of difficult to pipette, low surface tension samples like proteins.

Absorbance range specifications are published on the DeNovix website.

FX models include a fluorescence mode while the DS-11+ and DS-11 FX+ instruments also enable cuvette-based measurements for low concentration samples and basic absorbance kinetic studies.

Key Features

- Stand-Alone Design, no-PC Required
- Hi-Definition 7-inch Touchscreen Interface
- Simple, Intuitive EasyApps™ Software
- 1 µL and Cuvette Full Spectrum UV-Vis Analysis
- Four LED Excitation Options
- Wi-Fi, Ethernet and USB connectivity

Upgrade Options

- Add the USB connected FX Fluorometer Module to enable fluorometer measurement applications. Compatible with DS-11, DS-11+ and DS-C Spectrophotometers
- Activate 21 CFR Part 11 Compliance Ready Software.

2. Set up and Safety

1. Remove all packing materials.
2. Plug the unit into a 100-240 VAC, 50-60/Hz receptacle using the grounded power supply (Globtek part number TR9CE3000C95CP-NR6B / RoHS Compliant) included with each unit. Input Rating: 100-240V~, 50-60 Hz, IEC 60320/C14 , Output Rating: 36W, 12V@3A
3. Turn on the power switch located in the back of the instrument. The operating system will boot up in less than a minute.
4. Turn off the power switch to shut down the instrument.

Cautions

DO NOT REMOVE COVER

No operator serviceable components inside. Refer servicing to qualified personnel.

The DS-11 Series is designed for indoor use under the following conditions:

Temperature: 15° to 35° C

Humidity: 35 to 65 %

Elevation: 2000m or less

Pollution: Pollution degree 2



Use only the power supply provided with the instrument. Use of the instrument in any manner not specified by the manufacturer may impair the protection provided by the supplied power cord and power supply.

NE PAS OUVRIR L'APPAREIL.

Aucun composant réparable par un utilisateur est inclus. Confiez l'entretien à du personnel qualifié .

Le DS- 11 est conçu pour une utilisation en intérieur dans les conditions suivantes :

Température : 15° à 35°C

Humidité:35 à 65%

Utilisez uniquement le bloc d'alimentation inclus avec l'instrument. Utiliser l'appareil dans des conditions non spécifiées par le fabricant peut compromettre la protection offerte par le câble d'alimentation et le bloc d'alimentation fournis avec l'appareil.

Instrument Rear Panel

The DS-11 Series comes equipped with Wi-Fi, Ethernet and three USB ports. The USB ports are used to facilitate data transfer to a FAT32 formatted USB storage device and connect to the accessory FX Module. In addition, the USB ports support the use of select label printers* and an Opticon OPI 3601 USB barcode reader. USB mouse and keyboard devices may also be used with the DS-11 Spectrophotometer/Fluorometer.

* Please refer to our website for a list of supported label printers.

VCCI (Class B) compliance statement for users in Japan

This is a Class B product based on the standard of the Voluntary Control Council for Interference (VCCI) from Information Technology Equipment. If this is used near a radio or television receiver in a domestic environment, it may cause radio interference. Install and use the equipment according to the instruction manual.

This equipment has been tested for radio frequency emissions and has been verified to meet CISPR 22.2 Class B.



R 007-AH0184
T D190067007

「当該無線設備の送信は5.2GHz帯高出力データ通信システムの基地局又は陸上移動中継局と通信する場合を除き屋内においてのみ可能」

3. Instrument Diagram

DS-11 Series Component Details

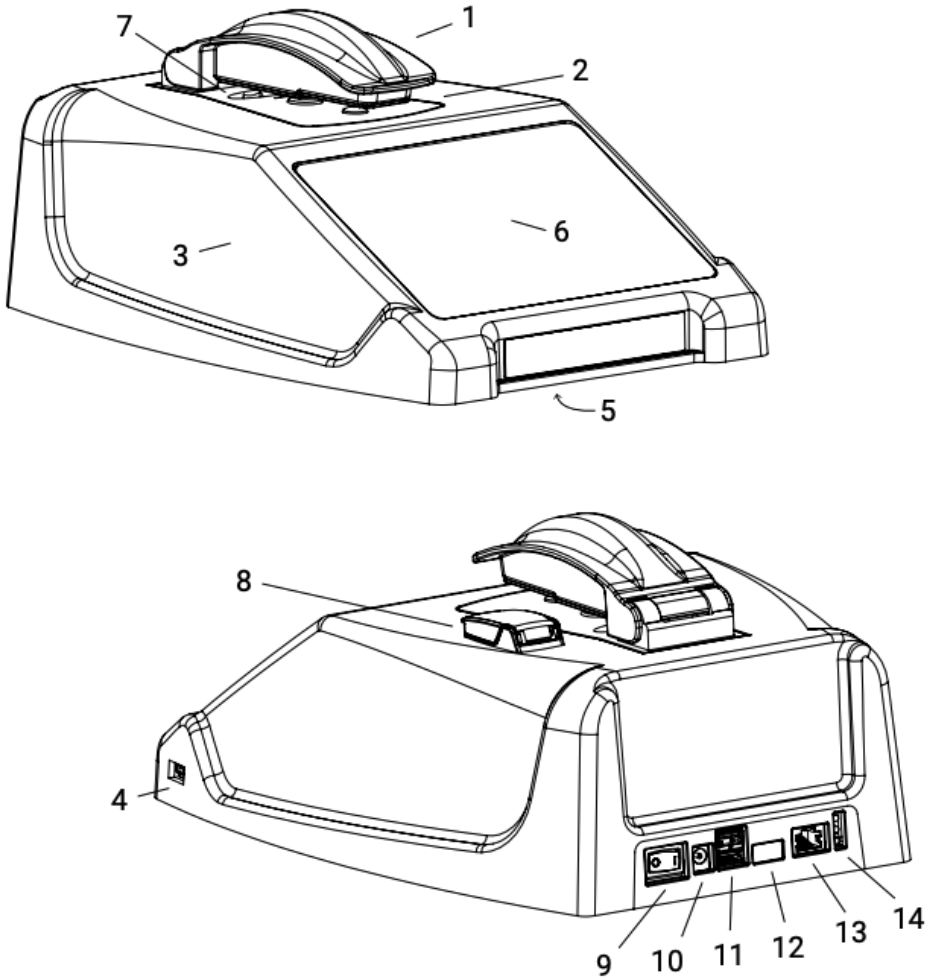



- 1. Arm
- 2. Sample surface
- 3. Cover
- 4. USB port
- 5. Serial number & regulatory info (underside)
- 6. Touchscreen
- 7. Cuvette port (optional)

- 8. Fluorometer port (optional)
- 9. Power switch
- 10. DC power in from power supply
- 11. USB ports (2)
- 12. Unused
- 13. Ethernet port
- 14. LED indications

4. Software Quick Guides









EasyApps™ Software Icons

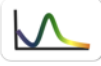
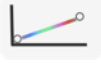

	Home		Add		Select All
	Overflow Menu		Edit		Export
	Purity Ratio Alert		Copy		Delete
	Information		Clear Selected		

	<p>Progress bars or busy indicators are used to indicate the instrument is in the process of making a measurement. Please wait until the icon has disappeared before performing additional actions.</p>
	<p>The Quick Print icon is only displayed on Report or Graph screens when a label printer is connected to the instrument.</p>
	<p>Auto Export status icons are displayed at the top right of a Run screen. Ensure Wi-Fi is connected prior to making a measurement.</p>

Software Buttons

Software Navigation

 	<p>The absorbance apps Blank button is used to establish a reference absorbance within each measurement app. The graph will not display a spectrum for a Blank measurement.</p> <p>The absorbance apps Measure button is used for sample measurements. It is inactive until a Blank measurement is complete.</p>
 	<p>The fluorescence apps Standards Measure button is used to measure standards when building a standard curve.</p> <p>The Samples Measure button is used to quantitate samples.</p>
	<p>The fluorescence apps Replicates On/Off button is used to define if the standards curve enables one or up to three replicates.</p>
	<p>The fluorescence apps Basic Measure button is used to make single measurements not being read from a standard curve.</p>
	<p>Fields with Drop-Down Menus are indicated by black or white triangles located on the center bottom.</p>
	<p>Fields with black underlines are editable by the user. Tapping on the field will enable a keyboard, a numeric keypad or a dialog box.</p>
	<p>Application specific editor options can be accessed using the List Add/Edit button found to the right of some drop-down menus.</p>
	<p>Options buttons are used for such purposes as change units or trend line analysis parameters in the fluorescence apps.</p>
	<p>An accept and return to previous screen button is found in the lower right of some screens. All changes made to a selection are immediate.</p>

	<p>Apps are launched using Home screen icons. Swipe the Home page to the left for additional icons.</p>
	<p>The app Run, Report and Graph screens are accessed either by the tabs on the top bar or by swiping the screens left or right.</p>
	<p>Use the Account Tab drop-down menu on the top action bar in the Run, Report and Graph screens to select a specific account within an app. Use the Accounts app to create and manage accounts.</p>

Top Bar Overflow Functions

Screen Capture	A .png may be exported as described in the chapter entitled "Screen Capture and Export" using this option.
Change Units	Concentration units may be changed in some apps using this option.
Clear Samples	This function saves and then clears all current sample records from the Report and Graph screens.
Baseline Correction	Some apps enable Baseline Correction changes from the Overflow function on the Run screen.
User Guide	The User Guide may be accessed either from the Overflow icon within any app or by launching the User Guide app.
About	The About feature brings up an information box displaying the current app version number.
Lamp Reset	The Diagnostics app Lamp Reset is used as a means to re-optimize a lamp when necessary.
Tech Support	The Diagnostics app Tech Support feature is used to send instrument related diagnostics files to DeNovix customer support.
Exit	Use the Exit function to close an application.

5. Absorbance Run Screen

Measurement applications generally use a three-page structure consisting of the Run, Report and Graph screens. The various screens are accessed either by using the top tabs or by swiping the touchscreen left or right.

Activation of **21 CFR Part 11 Compliance Ready Software** affects some aspects of the user interface. Where applicable, additional instructions for **21 CFR Mode** operation are provided. Contact DeNovix or your local Distributor to purchase an activation code.

Run Screen

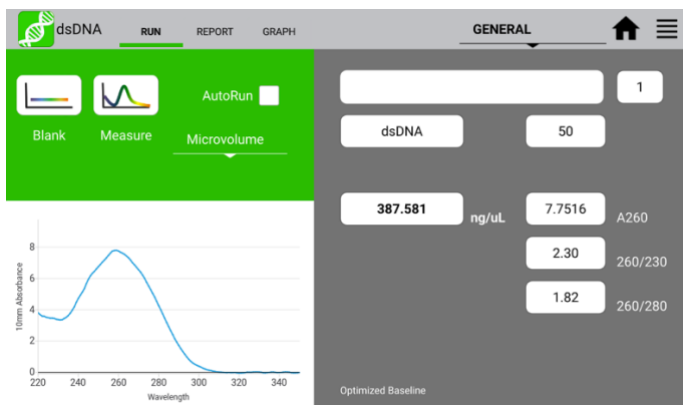

- **Blank and Measure:** Use the **Blank** button when blanking with the reference solution and the **Measure** button for samples.
- **Mode:** Use the drop-down to select the measurement mode.
- **Sample Name (optional):** Tap the input box to display an on-screen keyboard or use an Opticon OPI 3601 USB scanner to enter sample names.
- **Sample Type and Factor Fields:** Displays current sample type and associated factors used for concentration calculations. The fields may be fixed or selectable depending on the application.
- **Absorbance Graph:** The spectral plot displays data for the current sample normalized to a 10 mm pathlength for microvolume measurements. Pinch and zoom anywhere in the graph to rescale the X or Y-axis.
- **Baseline Correction nm:** Displayed at bottom of screen. Use the top action bar **Overflow** function to modify. Additional baseline correction details are provided within each relevant measurement app chapter.

Microvolume Measurements

1. Ensure both top and bottom sample surfaces are clean.
2. Pipette 1 μ L of the blank solution onto the lower sample surface. Lower the top arm and tap the **Blank** button.
3. Remove the solution from both sample surfaces using a clean, dry lab wipe.

4. Pipette 1 μL of the sample solution onto the lower sample surface.
5. Lower the arm and tap the **Measure** button. All microvolume measurements are reported in 10 mm equivalent absorbance values.

Cuvette Measurements

Refer to the light path arrow as a guide when inserting a cuvette. Use cuvettes that meet the following specifications:

- Width: 12.5 mm Length: 12.5 mm Height: 45 mm Z height: 8.5 mm
 - UV wavelength region: Use quartz or UV transparent plastic cuvettes
 - Visible wavelength region: Use quartz or plastic cuvettes
1. Insert a cuvette pre-filled with the Blank solution. Lower the arm and tap the **Blank** button.
 2. Insert a cuvette pre-filled with the sample solution. Lower the arm and tap the **Measure** button.

AutoRun

1. Perform a Blank as previously described and then select the **AutoRun** checkbox on the app Run screen. Pipette 1 μL of the sample solution onto the lower sample surface.
2. Lower the arm for automatic measurements. Deselect the feature to perform new Blank measurements. Note: This feature may be used for both microvolume and cuvette mode measurements.

Measurement Modes

- Measurement mode selections are made using the drop-down menu found next to the Measure button on the Run screen. Modes available vary depending on model.
- The **Microvolume** mode uses 1.0 μL samples pipetted onto the sample surface.
- The microvolume **Short Path** mode requires 0.5 μL samples pipetted onto the sample surface. This mode is for high concentration samples and does not use the 0.5 mm pathlength.
- The microvolume **Fast Mode** option is primarily for samples in the range measured by the 0.5 mm pathlength although it may be used for higher concentration samples.
- DS-11+ and DS-11 FX+ include 10, 5, 2, 1, 0.5, 0.2 and 0.125 mm pathlength **Cuvette** mode options.
 - Report screens will include actual absorbance values measured using a specific cuvette pathlength. Graph screens will display all cuvette absorbance values normalized to a 10 mm value.

- A new **Blank** must be made when changing between microvolume and cuvette modes.

21 CFR Mode Measurements

- Each blank and sample measurement requires an electronic signature in order to save a result. After each result select to discard or e-sign the result. Procedures are detailed in the 21 CFR Section of this user guide.
- AutoRun is disabled in 21 CFR Mode.

6. Absorbance Report and Graph Screens

Report Screen

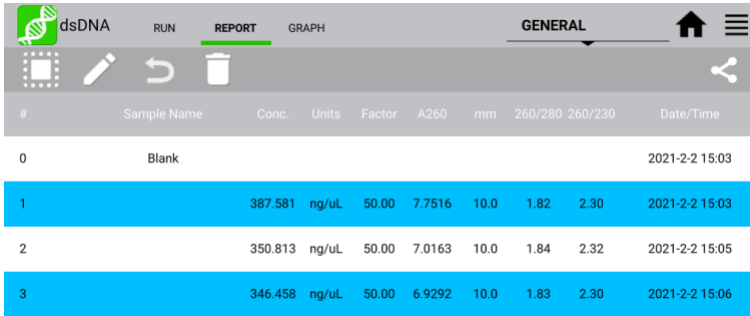

The screenshot shows the 'REPORT' screen in the dsDNA application. The top navigation bar includes 'dsDNA', 'RUN', 'REPORT', and 'GRAPH'. Below the navigation bar is an action bar with icons for grid, edit, undo, delete, and share. The main content is a table with the following columns: #, Sample Name, Conc., Units, Factor, A260, mm, 260/280, 260/230, and Date/Time. The table contains four rows of data, with rows 1, 2, and 3 highlighted in blue.

#	Sample Name	Conc.	Units	Factor	A260	mm	260/280	260/230	Date/Time
0	Blank								2021-2-2 15:03
1		387.581	ng/uL	50.00	7.7516	10.0	1.82	2.30	2021-2-2 15:03
2		350.813	ng/uL	50.00	7.0163	10.0	1.84	2.32	2021-2-2 15:05
3		346.458	ng/uL	50.00	6.9292	10.0	1.83	2.30	2021-2-2 15:06

- The Report screen list includes application specific data fields for each sample measured in the current measurement session.
- Tap rows to highlight and select data for export. The **Select All /UnSelect All** icons are used to quickly select or deselect all rows.
- The change will be applied to the current Report and Graph screen rows as well as to the sample information retrieved using the Data app.
- Clear highlighted sample records from the both the Report and Graph screens using the **Delete** icon. The data is removed from the current report but is still available using the Data app.
- Highlighted sample data may be exported or printed using the top action bar Overflow **Screen Capture** or **Export Selected** functions. Additional information is provided in the chapter entitled "Screen Capture and Export".

Graph Screen

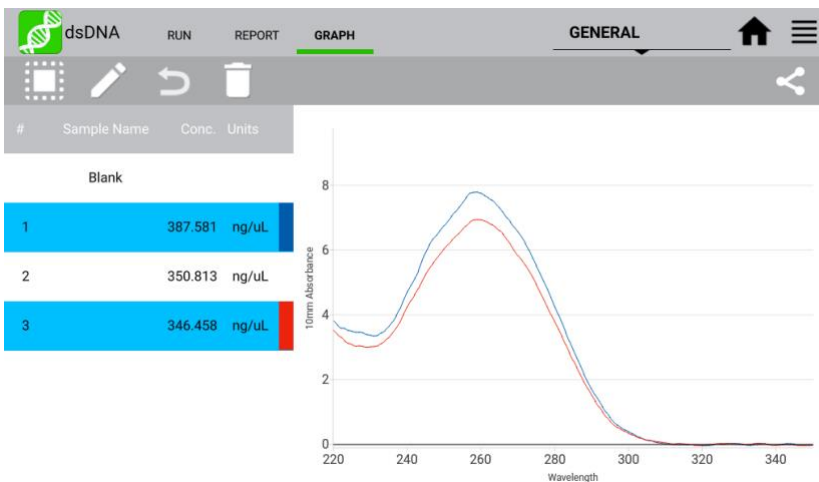

- Tap rows to highlight and select / deselect data to display the spectra. The **Select All** / **UnSelect All** icons are used to quickly select or deselect all rows.
- Up to 24 samples may be overlaid on the graph. Absorbance apps will display sample spectra while the fluorescence apps will display the concentration calculated from the standard curve trend line.
- Color blocks are used as a legend convention.
- Highlight a single row and then tap the **Edit** icon to add or modify a sample name. The change will be applied to the current Report and Graph screen rows as well as to the sample information retrieved using the Data app.
- Clear highlighted sample records from the both the Report and Graph screens using the **Delete** icon. The cleared data will be available using the Data app.
- Highlighted sample data may be exported or printed using the top action bar Overflow **Screen Capture** or **Export Selected** functions. The data will be exported as a .csv file and spectra may be re-graphed using a spreadsheet chart function. Additional information is provided in the chapter entitled "Screen Capture and Export".

7. Absorbance Best Practices

Best Practices for Absorbance Measurements

- Clean both sample measurement surfaces prior to making the Blank measurement.
- Use dH₂O, not detergents or alcohol, for routine sample measurement surface cleaning.
- Use a dry lab wipe to remove measurement liquids from both the top and bottom surfaces immediately after each measurement.
- Use 1 µL samples for routine microvolume measurements.
Note: Select the Short Path mode for high concentration 0.5 µL samples.
- Use a fresh aliquot for each measurement.
- Use a fresh tip to deliver each sample aliquot.
- Avoid introducing bubbles when pipetting samples onto the measurement surfaces.
- Ensure sample concentrations fall within absorbance limits of the instrument for accurate results.
- Use the same buffer a sample is suspended in for the Blank measurements.
- Avoid using buffers such as RIPA buffers that contain components with strong absorbances at the wavelength of interest.
- Measure a fresh aliquot of the buffer using the Measure button and ensure the spectrum is relatively flat along the baseline before measuring samples.
- For cuvette mode measurements, use cuvettes with 8.5 mm Z heights. Select the Cuvette option using the drop-down menu next to the Measure button and ensure the cuvette is inserted in the proper orientation.

8. Tech Team Tips

Initialization

- Before the system is powered on, remove all packaging or protective materials from between arm and sample surfaces.
- Follow on-screen instructions to clean the sample surfaces.
- Lower the arm and Press OK to complete the system Initialization.
- Although there is no harm in doing so, there is no need to shut down the instrument each day. The backlight for the screen will automatically turn off to protect the screen and will switch on when touched.

Connectivity and Results Data

- Use the Settings App to configure Wi-Fi or connect an ethernet cable to the rear ethernet port on the instrument.
- Within Settings configure email, network printers and network folders.
- Compatible label printer models enable immediate printing of results.
- Use the share icon  to export results to USB or one of the connected methods above.
- All results are saved on the device until deleted. Export during a measurement session or use the Data App to search for and export results later.
- For ease-of-use, an open access default General account is active when apps are opened. Use the User Accounts app to set up other accounts, password protect them if desired and configure app specific launch defaults as desired.

Software Updates

- Connect to the Internet and open the Updater App. Check for updates and download directly to the device. Alternatively, visit our website to download the update package to a FAT32 formatted USB drive. Insert the USB drive and then launch Updater.

Technical Support

- Visit the DeNovix website for instructional videos, Technical Notes and for troubleshooting tips. Contact your DeNovix Distributor or email info@denovix.com for help.

9. Absorbance Nucleic Acid Apps



dsDNA



RNA



ssDNA



Microarray

The four preconfigured nucleic acid apps are used to quantify nucleic acid samples based upon absorbance values at 260 nm.

Quick Protocol

1. Launch the appropriate application from the **Home** screen.
2. Establish a **Blank** using the appropriate buffer.
3. Enter a sample name.
4. Select a sample type if applicable.
 - Enter optional user-defined ng-cm/ μ L factor (*ssDNA and Microarray*).
 - Select a dye type (*Microarray only*).
5. Measure a fresh aliquot of sample using the **Measure** button.

Notes:

- *Blank with TE if the sample is dissolved in TE.*
- *Ensure that the sample isolation procedure is optimized and that samples are purified prior to making absorbance measurements.*
- *Ensure all solutions are homogenous and well-mixed prior to sampling.*
- *Use fresh aliquots for each microvolume measurement.*

dsDNA, RNA and ssDNA

The basic nucleic acid apps are optimized for the measurement parameters used to calculate sample concentrations.

Screen Features

- **Sample Type:** The sample type is used to determine which ng-cm/ μ L factor is used to calculate the concentration.
 - The sample type is fixed for both the dsDNA and RNA apps.
 - A **Factor Input** option along with the default ssDNA sample type is available from the selector field for the ssDNA app.
- **Factor:** The default wavelength-dependent factors used for each app are as follows:
dsDNA: 50 ng-cm/ μ L RNA: 40 ng-cm/ μ L ssDNA: 33 ng-cm/ μ L
 - Oligo factors derived from the Calculator app may be copied and pasted directly into this field.
- **Concentration Results:** Concentration results are reported in units of ng/ μ L.
 - Units may be changed using the Run screen top action bar Overflow menu. The units selected at the time of the measurement are saved to the database.
- **A260:** Reports the baseline-corrected 260 nm absorbance value.
- **260/230:** Displays the ratio of the 260 nm and 230 nm absorbance values.
- **260/280:** Displays the ratio of the 260 nm and 280 nm absorbance values.

Note: The DNA and RNA apps do not distinguish between the nucleic acid species within a sample. It is important to optimize the isolation protocol to ensure accurate quantitation.

Microarray

The Microarray app is used to quantify nucleic acid samples based upon absorbance values at 260 nm and dyes based upon dye specific analysis wavelengths.

Screen Features

- **Sample Type:** The sample type selection of ssDNA is the default option for this application. Options include:
 - ssDNA (Factor = 33 for nucleic acid concentration calculation.)
 - RNA (Factor = 40 for nucleic acid concentration calculation.)
 - Factor Input to enable a user-defined nucleic acid factor. Oligo factors derived from the Calculator app may be copied and pasted directly into this field.
- **Dye Type:** Cy3 is default selection for this application.
- **Nucleic Acid Concentration Results:** Results are reported in units of ng/ μ L.
 - Units may be changed using the Run screen top action bar Overflow menu. The units selected at the time of the measurement are saved to the database.
- **Dye/Fluorophore Concentration Results:** Results are reported in units of μ M.
- **A260*:** Reports the baseline and dye corrected 260 nm absorbance value. This value may be lower than the A260 value observed in the absorbance spectra due to the correction factors applied.
- **AXXX:** The baseline-corrected dye specific analysis wavelength absorbance value (e.g A550 when using the Cy3 dye).

Dye List

There are 11 preconfigured dye types available for both the Microarray and Labeled Proteins applications. New dye types may be saved using the List Add/Edit button to the right of the dye list drop-down menu. Refer to the manufacturer of the dye for analysis nm, extinction coefficient and correction factor information.

Dye	Ext. Coeff	A260 Factor	A280 Factor
Cy3	150000	0.08	0.08
Cy5	250000	0.05	0.05
Cy5.5	250000	0.05	0.18
Alexa Fluor 405	34,000	0.23	0.7
Alexa Fluor 488	71,000	0.3	0.11
Alexa Fluor 555	150,000	0.08	0.08
Alexa Fluor 594	90,000	0.43	0.56
Alexa Fluor 647	239,000	0	0.03
Alexa Fluor 680	184,000	0	0.05
Alexa Fluor 700	192,000	0	0.07
Fluorescein/FITC	68000	0.32	0.2

Dyes saved to the list are accessible for both the Microarray and Labeled Proteins apps. The new dyes may be used by all accounts, including the General Account. The user-added dyes may only be edited or deleted by the account holder or an administrator.

The following information is required in order to save a new dye to the list:

- Dye name
- Analysis wavelength
- Analysis wavelength specific molar absorption coefficient ($M^{-1} \text{ cm}^{-1}$)
- 260 nm absorbance correction factor
- 280 nm absorbance correction factor

Preconfigured dyes may not be modified or deleted.

Baseline Correction for Dyes

The software anchors the visual spectrum display to the baseline at 750 nm for all measurements. It automatically applies a 340 nm bichromatic normalization for the A260 value and uses a sloping baseline between 400 and 750 nm for dye concentration calculations.

If adding a new dye, it is important to empirically determine if the default 750 nm selection is appropriate to use as the baseline correction wavelength.

- The baseline correction screen is accessed from the Run screen top action bar Overflow icon.
- Tap the **Add** icon to include a user-defined option between 750 and 840 nm.
- The new option will be used for both the visual display and the sloping dye baseline.
- Once a baseline correction nm is selected, it is applied to all subsequent measurements and is not dye specific. When changing dyes, always confirm that the proper baseline correction is applied.

Nucleic Acid Concentration Calculations

A modified Beer-Lambert equation is used to calculate concentrations as follows:

$$c = (A * e) / b$$

c = the nucleic acid concentration in ng/microliter

A = the absorbance in AU

e = the wavelength-dependent factor in ng-cm/microliter

b = the pathlength in cm (10 mm)

Baseline Correction

Baseline corrections correct for offsets due to sample particulates. If a baseline correction is not used, the sample spectrum may be offset from the baseline, resulting in a change in the reported sample concentration. The DS-11 uses an optimized baseline correction as the default selection. However, the user may elect to define the baseline nm used for specific measurements.

The baseline correction screen is accessed from the Run screen top action bar Overflow icon. Once a baseline correction nm is selected, it is applied to all subsequent measurements within the same measurement session.

Purity Ratios

- The generally accepted 260/280 values are ~1.8 for pure DNA and ~2.0 for RNA.
- The 260/230 values for nucleic acids usually range between 1.8 and 2.2.

Troubleshooting Purity Ratios

Issue	Probable Causes/ Solutions
Low 260/230	Dirty measurement surfaces or improper Blank. Clean the surfaces, measure a new Blank using fresh source of dH₂O or sample buffer. Use the same solution (water or buffer) the sample is in for the blank measurement.
	Presence of residual extraction reagent (ex. Carbohydrates, Chaotropic salts, phenol). Re-purify the sample, then remeasure. Contact the manufacturer of the extraction kit for guidance on how to optimize the procedure.
High 260/230	Dirty measurement surfaces or improper Blank. Clean the surfaces, measure a new Blank using fresh source of dH₂O or sample buffer. Use the same solution (water or buffer) the sample is in for the blank measurement.

Low 260/280	<p>Dirty measurement surfaces or improper Blank. Clean the surfaces, measure a new Blank using fresh source of dH₂O or sample buffer. Use the same solution (water or buffer) the sample is in for the blank measurement.</p>
	<p>Presence of residual extraction reagent (ex. protein, phenol). Re-purify the sample, then remeasure. Contact the manufacturer of the extraction kit for guidance on how to optimize the procedure.</p>

High 260/230	<p>Dirty measurement surfaces or improper Blank. Clean the surfaces, measure a new Blank using fresh source of dH₂O or sample buffer. Use the same solution (water or buffer) the sample is in for the blank measurement.</p>
--------------	---

Ratio Alerts

The DS-11 Series software displays alert icons within the dsDNA, RNA and ssDNA apps for samples with purity ratios outside of specified minimum and maximum limits. Tapping on the icon will pop-up a message with alert-specific information.

The default settings are as follows:

Ratio	Minimum	Maximum
260/230	1.8	3
260/280	1.65	2.5

Users may elect not to have the alerts show or set custom limits using the Run screen Overflow menu. The new limits may be used by all accounts, including the General Account. Saved user-added limits may only be edited or deleted by the account holder or an administrator account holder.

Note: The limits are only enforced for samples above a minimum concentration value. A blue warning icon will be displayed when the sample concentration is below the threshold. This warning relates to the validity of ratio measurements at low absorbance readings, not the accuracy of concentration measurements.

10. Absorbance Purified Protein, Peptide Apps



Protein
A280



Labeled
Proteins



Peptides

Quick Protocol

1. Launch the appropriate application from the **Home** screen.
2. Establish a **Blank** using the appropriate buffer.
3. Enter a sample name.
4. Select a sample type.
 - New protein or peptide types may be added to the selection list.
 - Select a dye type when using the Labeled Proteins app.
5. Measure a fresh aliquot of sample using the **Measure** button.

Notes:

- *If the buffer exhibits significant absorbance at 280 nm, use alternative methods such as colorimetric assays to quantitate proteins.*
- *Ensure all solutions are homogenous and well-mixed prior to sampling.*
- *Use fresh aliquots for each microvolume measurement.*

Protein A280

The Protein A280 application is used to quantify samples based upon absorbance values at 280 nm.

Screen Features

- Sample Type: The sample type and associated mass extinction coefficients options include:

Use the 1A=1mg/ml option when neither the E1% nor Ext Coeff and MW for the purified protein sample are known.

- Concentration Results: Results are reported in units of mg/mL.
 - Units may be changed using the Run screen top action bar Overflow menu. The units selected at the time of the measurement is what is saved to the database.
- A280: Reports the baseline-corrected 280 nm absorbance value.
- 260/280: Displays the ratio of the 260 and 280 nm absorbance values.

Protein Type List

New Protein types using either user-defined E1% or MW and Ext. Coeff values may be saved using the List Add/Edit button to the right of the sample type drop-down menu.

- The new sample types may be used by any account holder.
- The new sample types may be edited or deleted only by the account holder or an administrator account.

Sample Type	E1% at 280 nm for 10 mm pathlength
BSA	6.67
1A=1mg/mL	10
IgG	13.7
E1%	User-defined mass extinction coefficient ($L\text{ gm}^{-1}\text{ cm}^{-1}$) for a 10 mg/mL (1%) solution
MW & Ext Coeff	User-defined MW (Daltons) and molar extinction coefficient ($M^{-1}\text{ cm}^{-1}$)

Baseline Correction

Bichromatic normalizations correct for baseline offsets due to sample particulates. If a baseline correction is not used, the sample spectrum may be offset from the baseline, resulting in a change in the reported sample concentration. The DS-11 uses an optimized baseline correction as the default selection. However, the user may elect to define the baseline nm used for specific measurements.

The baseline correction screen is accessed from the Run screen top action bar Overflow icon. Once a baseline correction nm is selected, it is applied to all subsequent measurements within the same measurement session.

Labeled Proteins

The Labeled Protein application is used to quantify protein samples based upon absorbance values at 280 nm as well as Dyes and Fluorophores at specific analysis wavelengths.

Screen Features

- Sample Type: The sample type and associated mass extinction coefficients options include:

Sample Type	E1% at 280 nm for 10 mm pathlength
BSA	6.67
1A=1mg/mL	10
IgG	13.7
E1%	User-defined mass extinction coefficient ($L\text{ gm}^{-1}\text{ cm}^{-1}$) for a 10 mg/mL (1%) solution
MW & Ext Coeff	User-defined MW (Daltons) and molar extinction coefficient ($M^{-1}\text{ cm}^{-1}$)

- Dye Type: Cy3 is default selection for this application.
- Protein Concentration Results: Results are reported in units of mg/mL.
 - Units may be changed using the Run screen top action bar Overflow menu. The units selected at the time of the measurement is what is saved to the database.
- Dye/Fluorophore Concentration Results: Results are reported in units of μM .
- A280*: Reports the baseline and dye corrected 280 nm absorbance value. This value may be lower than the A280 value observed in the absorbance spectra due to the correction factors applied.
- AXXX: The baseline-corrected dye specific analysis wavelength absorbance value (e.g A550 when using the Cy3 dye).

Protein Type List

New Protein types using either user-defined E1% or MW and Ext. Coeff values may be saved using the List Add/Edit button to the right of the sample type drop-down menu.

- The new sample types may be used by any account holder.
- The new sample types may be edited or deleted only by the account holder or an administrator account.

Dye List

There are 11 preconfigured dye types available for both the Microarray and Labeled Proteins applications. Refer to the "Microarray" section of the chapter entitled "Nucleic Acids" for more information.

Baseline Correction

The software anchors the visual spectrum display to the baseline at 750 nm for all measurements. It automatically applies a 340 nm bichromatic normalization for the A280 value and uses a sloping baseline between 400 and 750 nm for dye concentration calculations.

If adding a new dye, it is important to empirically determine if the default 750 nm selection is appropriate to use as the baseline correction wavelength.

- The baseline correction screen is accessed from the Overflow icon.
- Tap the **Add** icon to include a user-defined option between 750 and 840 nm.
- The new option will be used for both the visual display and the sloping dye baseline.
- Once a baseline correction nm is selected, it is applied to all subsequent measurements and is not dye specific. When changing dyes, always confirm that the proper baseline correction is applied.

Peptides

The Peptide app is used for low concentration samples which do not have aromatic residues such as Trp, Tyr or Cys-Cys disulphide bonds. The Protein A280 app is recommended when the sample does contain aromatic rings.

Screen Features

- Sample Type: The first two sample types included in the sample type drop-down are preconfigured for both the analysis wavelength and the corresponding E 0.1%.
- Sample type and associated E 0.1% coefficients options include:

Sample Type	E 0.1% at specified nm for 10 mm pathlength	Analysis Wavelength
e215 nm	11.7	215 nm (recommended)
e205 nm	31	205 nm
E0.1%	User-defined mass extinction coefficient ($L\text{ gm}^{-1}\text{ cm}^{-1}$) for a 1 mg/mL (0.1%) solution	215 or 205 nm User Option

- Analysis Wavelength Selector: The radio button selector will appear for all sample types except the preconfigured e215 nm and e205 nm options. Note: Extinction coefficients are wavelength dependent.

- Concentration Results: Results are reported in units of mg/mL.
 - Units may be changed using the Run screen Overflow menu. The units selected at the time of the measurement is what is saved to the database.
- AXXX: Reports the baseline-corrected analysis wavelength absorbance values (e.g A205 or A215).

Protein and Peptide Concentration Calculations

The Beer-Lambert equation is used to calculate concentrations as follows:

$$A = E1\% * b * c$$

c = the protein concentration in g/100 mL

A = the absorbance in 10 mm equivalent

E1%= the percent extinction coefficient ($L\text{ gm}^{-1}\text{ cm}^{-1}$) for a 10 mg/mL (1%) solution

b= the pathlength in cm (10 mm)

The following equation is used to convert g/100 mL to mg/mL concentrations:

$$c\text{ (mg/mL)} = (A/E1\%) * 10$$

The relationship between percent extinction coefficient (E1%) and molar extinction coefficient (Ext. Coeff) is:

$$E1\% = (\text{Ext. Coeff} * 10) / \text{molecular weight of protein (Daltons)}$$

Note: The Peptide app uses E 0.1% values whereas the Protein A280 app uses E 1% values.

The DeNovix software reports concentrations in mg/mL units for the Protein A280, Labeled Protein and Peptide applications. The concentration is determined based upon the absorbance value at the analysis wavelength used for the measurement.

Ratio Alerts

The DS-11 Series software displays alert icons within the Protein A280 for samples with A260/280 purity ratios outside of specified maximum limits. Tapping on the icon will pop-up a message with error specific information.

In general, pure protein samples will have a ratio below 0.57. The default software value that will trigger an alert is 0.7.

Users may elect not to have the alerts show or set custom limits using the Run screen Overflow menu. The new limits may be used by all accounts, including the General Account. Saved user-added limits may only be edited or deleted by the account holder or an administrator account holder.

Note: The limit is only enforced for samples above a minimum concentration value. A blue warning icon will be displayed when the sample concentration is below the threshold. This warning relates to the validity of ratio measurements at low absorbance readings, not the accuracy of concentration measurements.

11. Absorbance Colorimetrics App

Refer to the manufacturer of the assay reagent for assay specific instructions.



BCA

Bradford

Lowry

Pierce 660

Quick Protocol

1. Launch the app from the **Home** screen.
2. Select the assay type on **Run** screen. Navigate to the **Standard Curve** screen.
3. Select the appropriate microvolume or cuvette mode prior to making the Blank measurement.
4. Establish a **Blank** using the appropriate buffer or the 0.00 mg/mL standard.
5. Generate a new Standard Curve by measuring at least one replicate for a minimum of 2 standard concentrations. Alternatively, apply a previously saved curve selected from the drop-down menu.
6. Navigate to the **Run** screen.
 - Optional: Enter a sample name and dilution factor to be applied to the reported concentration.
7. Quantitate the sample using the **Measure** button.
8. Notes:
 - *The Graph Flip button is available on the Run and Graph Screens in the Colorimetrics and Custom Standard Curve apps. The flip option is not available when reviewing the results in the Data app. Only the absorbance style graphs will be displayed.*
 - *Standard Concentrations: Minimum 2, Maximum 8.*

Generating a Standard Curve

1. Use the drop-down menu on the Std Curve screen to select **New Curve** or to import a saved standard curve or standard curve concentration list.
2. If the **New Curve** option is selected, tap the **Enter Standards** button to enable a pop-up box to enter a list of standard concentrations for the current measurement session.
 - The table enables up to 7 standard concentrations in addition to the predefined 0.00.
 - The 0.00 concentration is used for the diluent (no analyte) plus the assay reagent. Although not recommended, the 0.00 concentration may be edited.
3. Measure at least one replicate of each standard concentration by highlighting the standard concentration row and then tapping the **Measure** button.

- Up to 5 replicates may be measured for each concentration. Use fresh aliquots for each measurement when using the microvolume mode.
- The software will advance after each measurement until the fifth replicate has been measured. If additional measurements are made, the fifth position will be overwritten.
- A minimum of two standards must be measured before the **Measure** button is active on the Run screen.
- Select a standard row or individual replicate then tap the **Delete** icon to display a drop-down list of delete options.
- Use the **Undo** icon to restore the most recent edit or delete action.

Line Fit

The average of the replicates is used to determine a best-fit trend line of the data set. The trend line equation is applied to the sample absorbance values to calculate concentrations.

Options include:

- Linear
- 2nd Order
- Interpolation: This option draws a straight line between each point.

Note: The software will extrapolate concentrations for samples with absorbances 15% above the absorbance values associated with the highest standard for linear fits only.

Saving a Standard Curve

A standard curve or a series of standard concentrations may be saved and reused at a later date.

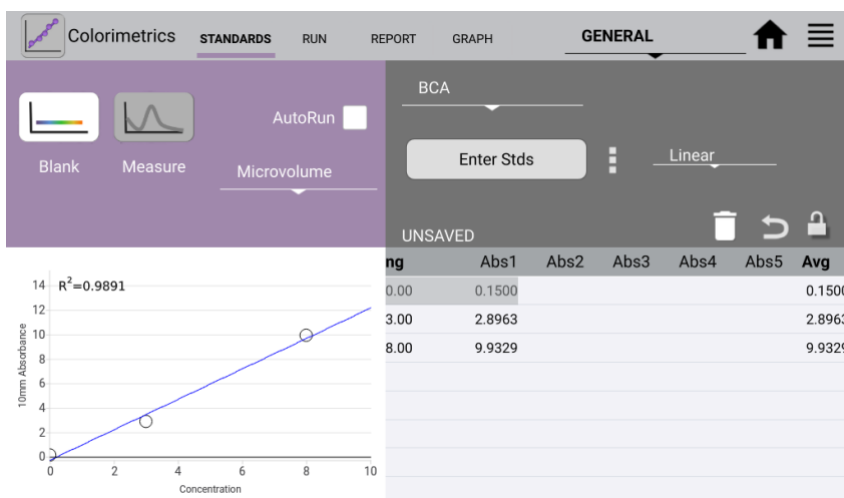

- Use the List Add/Edit button to the right of the curve list drop-down menu to save a curve or concentration list.

Editing a Standard Curve

- The curve is in an editable state when the Lock icon is unlocked.
- When a previously saved curve or concentration list is imported, a red Lock icon will appear. Tap the icon to unlock the curve data set to enable modifications and new absorbance measurements.
- All modifications to a curve (new or saved) are effective **immediately**. It is important to save a curve with a new name prior to making any changes if you do not want to modify the original curve.
- The only way to recall absorbance data for a standard curve is to save the results as a saved curve before exiting the app.

- Although all accounts may use any previously saved standard curve or saved concentration list, only the curve account holder or an administrator may modify or delete a saved curve or concentration list.

Exporting a Standard Curve

The standard curve replicate values may be exported using the Screen Capture function described in the chapter entitled "Screen Capture and Export."

Note: The standard curve data is not available in a .csv format. Use the Screen Capture function to export a .jpg showing the curve replicate values.

BCA

The bicinchoninic acid assay (BCA assay) is used to quantify protein by measuring the Cu-BCA chelate formed in the presence of protein.

- The reaction product is measured at 562 nm using a baseline correction at 750 nm.

Bradford

The Bradford assay is based upon a protein-induced absorbance shift of a Coomassie Blue dye as a method to determine protein concentration.

- The reaction product is measured at 595 nm using a baseline correction at 750 nm.

Note: Some Bradford formulations may form particulates during prolonged incubations. It is recommended that the cuvette option be used when using these types of formulations. The particulates may interfere with the shorter pathlengths used for the microvolume measurements.

Lowry

The modified Lowry assay is used to quantify proteins based upon the absorbance of tetradentate copper-protein complexes.

- The reaction product is measured at 650 nm using a baseline correction at 405 nm.

Pierce 660

The Pierce 660 nm Protein Assay is used to measure a reddish-brown dye-metal complex that changes to green upon protein binding.

- The reaction product is measured at 660 nm using a baseline correction at 750 nm.

12. Absorbance UV-Vis App



UV-Vis

The UV-Vis app is used to monitor up to 6 specific analysis wavelengths. Absorbance values for all wavelengths from the user selected wavelength ranges are saved for each measurement and can be exported as a .csv file using the Export function from the Report or Graph screens.

Quick Protocol

1. Launch the **UV-Vis** application from the **Home** screen.
2. Establish a **Blank** using the appropriate buffer.
3. Enter the analysis nm in the first input field. This wavelength is used to determine which pathlength is utilized by the SmartPath™ technology for microvolume measurements. Enter up to five additional wavelengths of interest.
4. Enter a sample name.
5. Measure a fresh aliquot of sample using the **Measure** button.

Wavelength List

A list of between 1 to 6 wavelengths may be saved and recalled by using the Overflow icon to the right of the wavelength list drop-down menu.

Wavelength Range Selection

There are two wavelength ranges available for the UV-Vis app. Use the checkbox feature to select between the 220 to 750 nm or the 190 to 840 nm options. Changing ranges will automatically save and then clear current results. A new Blank is required when switching ranges.

Use the Custom Formula App to create a method that utilizes a user-defined wavelength range.

Cursor Position

The UV-Vis app Run Screen graph includes a moveable cursor initially set at the analysis wavelength. Moving the cursor allows the user to find the absorbance value of any wavelength after a measurement is made.

Note: The cursor wavelength absorbance value is a temporary value not saved by the software.

Baseline Correction

The baseline correction normalizes the entire spectrum using the absorbance value of the wavelength specified and corrects for baseline offsets due to sample particulates. The default selection is set to 750 nm for the UV-Vis app.

If a baseline correction is not used, the sample spectrum may be offset from the baseline, resulting in a change in the reported sample concentration.

The baseline correction list is accessed from the Overflow icon. Once a baseline correction nm is selected, it is applied to all subsequent measurements within the same measurement session.

13. Absorbance OD 600 App



OD 600

This application is generally used to determine the optical density of microbial cell cultures at 600 nm. Conversions to cells per mL are based upon a user-defined factor.

Quick Protocol

1. Launch the app from the **Home** screen.
2. Establish a **Blank** using the appropriate buffer.
3. Enter a sample name.
4. Enter a cell conversion factor (optional).
5. Measure a fresh aliquot of sample using the **Measure** button.

Notes:

- *All cell type specific conversion factors are user derived.*
- *Ensure culture is well mixed prior to sampling.*
- *Use fresh 1 μ L aliquots for each microvolume measurement.*
- *Although microvolume OD 600 measurements can be made, the cuvette 10 mm mode is recommended for this app. This option is available on the DS-11+ and DS-11 FX +.*

Unique Features

- **A600:** The OD 600 is a measure of the light scattered by the cell suspension solution. Reported values may differ for the same sample measured on different spectrophotometer systems as values are dependent on both the cell type and the optical configuration of the spectrophotometer.
 - **It is recommended that an optimal harvest density and the linear range of growth curves be empirically determined for each microbial cell type when using a new spectrophotometer.**
- **Cell Number Conversion Factor:** The cell number conversion factor is used to convert the 600 nm value into the number of cells per mL for the sample by multiplying the absorbance value by the factor. Cell numbers are reported in terms of 1×10^8 cells. The factor must be entered into the appropriate field prior to a measurement.

Note: The cuvette mode selection (i.e the path length) must be taken into account when determining target OD 600 values or entering cell conversion factors. When making microvolume measurements, the OD 600 values reported and used for cell number calculations are 10 mm equivalent values.

Baseline Correction

As microbial cell culture OD 600 values are measurements of light scattering, the DS-11 software does not use a bichromatic baseline normalization unless specified as a user selection.

The baseline correction screen is accessed from the Overflow icon. Once a baseline correction nm is selected, it is applied to all subsequent measurements within the same measurement session.

14. Absorbance Kinetics App



Kinetics

The Kinetics application is a cuvette mode only application available for the DS-11+ and DS-11 FX+ models.

Quick Protocol

1. Launch the app from the **Home** screen.
2. Use the **Create Method** button on the **Run** screen to define the parameters of the method.
 - The button will change to a drop-down menu after at least one method has been defined. Use the **List Add/Edit** button to the right of the drop-down to define additional new methods or edit previously saved methods.
3. Navigate to the **Run** screen and tap the Heater button to preheat the cuvette block to the selected temperature.
4. When the Heater temperature field displays the set temperature, insert the cuvette and establish a **Blank** using the appropriate buffer.
5. Insert the cuvette with the sample solution and tap the **Measure** button.

Notes:

- *Use cuvettes with Z heights of 8.5 mm. Use the light path arrow as a guide when inserting a cuvette into the cuvette block.*
- *Use a quartz or UV transparent plastic cuvette when using methods that include the UV wavelength range.*

Define Method Screen Features

- **Method Name:** A unique name is required for each method.
- **Analysis nm:** Enter the primary wavelength of interest for the method. The absorbance value at this wavelength will be plotted versus time on the Trend plot.
- **Analysis nm 2:** Optional 2nd wavelength of interest for the method. The absorbance value at this wavelength will be plotted versus time on the Trend plot.
- **Wavelength Range:** Define a range between 190 to 840 nm.
- **Baseline Correction Wavelength:** 750 nm is the general recommendation, but the optimal wavelength should be empirically determined.
- **Heater Set Point:** The heater may be set to temperatures between 37°C to 45°C.

Stage Selections

Up to three stages of timed intervals may be included for each method. The parameters for each stage include:

- Delay: This is the time before the first measurement of each stage.
- Interval: This is the time between measurements. The minimum interval is 5 seconds.
- Duration: This is the cumulative time of the individual stage **not** including the delay. A duration will be rounded down to the nearest even multiple of the interval.

Example: Interval = 10 seconds, Duration = 31 seconds
Duration rounded down to 30 seconds.

Run Screen Features

- Method: Select the method of choice using the drop-down menu. Use the List Add/Edit button to the right of the drop-down to create or edit methods. All methods are available to all accounts however, only the account holder or an administrator may edit or delete a method.
- Graph Type Flip Button: Graph types may be switched during the run.
 - Spectra: Absorbance vs wavelength
 - Trend: Absorbance vs elapsed time for analysis wavelength(s)
- Heater Control: Tap the **On/Off** button to control the heater. The heater may overshoot the method set point before reaching a equilibrium $\pm 0.5^{\circ}\text{C}$ of the set point.
- Timer: This feature is used to monitor the sample solution warm-up time. The timer is used in a count-up only mode but is not used to track the measurement time.
- Stop Button: A **Stop** button replaces the Measure button on the Run screen during the Kinetics run. Tapping this button will end the measurement and save all data accumulated up to that point. The Measure button will be available when the run is finished.
- Results Table: A scrollable table with the absorbance values at the specified wavelength(s) per time is displayed on the Run screen.

Heater Temperature

- The temperature display box is color-coded for quick reference:
 - White: Heater is off.
 - Yellow: Heater is on, heater is not at method set point.
 - Orange: Heater is on, cuvette holder block has reached the method set point within $\pm 0.5^{\circ}\text{C}$.

Sample Solution Temperature

- The solution in the cuvette may not reach the set point as quickly as the heater. Use the Run screen timer as a means of monitoring the elapsed warm-up time. Below are estimated warm-up times.

The times were determined after a 10 mm plastic disposable cuvette filled with water was inserted into the cuvette block already heated to the method set point. Actual times may vary and should be empirically determined for each assay protocol.

- The temperature display box does not measure the temperature of the solution in the cuvette.

Solution Start Temp	4°C		Room Temperature	
Heater Set Point Temp	37°C	45°C	37°C	45°C
Warm-up Time (mins)	15 to 20	15 to 20	10 to 15	10 to 15

Report, Graph, Trend Screens

- Report Screen: Unlike other DS-11 measurement apps, the results displayed in the Kinetics Report screen list are associated with one assay run. Each time a new assay run is initiated, the previous results will be saved and then cleared from the Report, Graph and Trend screens. The cleared data may be accessed using the Data app.

Note: It is normal for the software to experience minor delays in reporting kinetics data information relative to the actual measurement time point. The actual time each measurement is initiated is what is reported in the Elapsed Time field.

- Graph Screen: Displays the absorbance for the method-defined wavelength range for each time point.
- Trend Screen: Displays the absorbance vs. elapsed time for method-defined analysis wavelength(s). Use the action bar timers to narrow the time points for export or screen capture.

15. Absorbance Custom Methods Apps



Std Curve Methods



Formula Methods

These applications are used to create, save and access user-defined methods.

Quick Protocol

1. Launch the applicable **Custom Methods** app from the **Home** screen.
2. Use the **Create Method** button on the **Run** screen to define the parameters of the method.
 - The button will change to a drop-down menu after at least one method has been defined.
 - Use the **List Add/Edit** button to the right of the drop-down to define additional new methods or edit previously saved methods.
 - All methods are available to all accounts however, only the account holder or an administrator may edit or delete a method.
3. Establish a **Blank** using the appropriate buffer. If the method is a standard curve type, establish the Blank and measure the standards from the **Std Curve** screen before navigating to the **Run** screen.
4. Enter a sample name (optional).
5. Measure a fresh aliquot of sample using the **Measure** button.

Primary Settings

Each new method requires a unique name. In addition, the following parameters must be defined:

- Analysis nm: Enter the primary wavelength of interest for the method.
 - Absorbance values at the analysis nm will be used to generate a curve for Standard Curve methods. The analysis nm will be also be used to determine which pathlength is utilized by the SmartPath™ technology for microvolume measurements.
- Baseline nm: A baseline correction wavelength is required for the Standard Curve methods but not for the Formula Methods. Bichromatic normalizations correct for baseline offsets due to sample particulates. If a baseline correction is not used, the sample spectrum may be offset from the baseline.
 - Although the general recommendation would be to use 340 nm for UV only wavelength ranges and 750 nm for full range methods, the optimal baseline correction wavelength should be empirically determined.
- Wavelength Range: The software will perform a wavelength optimization function each time the wavelength range is defined or edited within a method.

Custom Standard Curve Methods

In addition to the primary settings described above, the Standard Curve app also requires that a units label be defined.

- Once a new method is established or a previously saved method is selected, navigate to the Std Curves screen and follow the steps outlined for Generating a Standard Curve in the chapter entitled "Colorimetrics".
- Standard Curve methods function the same way as preconfigured Colorimetrics apps.

Custom Formula Methods

In addition to the primary analysis wavelength, the Formula Methods app enables the user to include up to four additional results for each measurement. The result fields may be used to monitor additional specific wavelengths or have the software perform routine calculations based upon absorbance values measured at specific wavelengths.

- **Result Name:** Enter a name for each custom formula.
- **Custom Formulas:** Tap on the custom formulas input field to display a pop-up dialog. The following functions are available:
- **Advanced:** When checked, this feature allows the user to designate that the method uses a Savitzky–Golay filter instead of the default boxcar method to smooth data.

Function	Description
Numerical Operations	+ add - subtract * multiply ÷ divide
A(x)	Absorbance at wavelength x
Log(x)	Log of x
In(x)	Natural Log of x
^	Exponent Example 4^3 equals 4x4x4
√	Square Root
e	Scientific notation Example 2e3 equals 2 x 10 ³ or 2000
V1, V2	Variables that are entered on the Run screen prior to each measurement.

Formula Guidelines

- Use the A(x) button on the input screen to use the absorbance value result of a specific wavelength in the formula. Enter the wavelength within the parenthesis.

Example: A(260)

- Check that closed sets of parentheses are included when entering complex formulas.

Example: Log(A(260)) is correct. Log(A(260) is incomplete.

- Do not enter an equal sign before the equation. This is implied within the software.

Example: A(260)/A(280) is correct while = A(260)/A(280) is incorrect.

- The software automatically applies the baseline correction specified in the method set-up. Do not include baseline corrections in user-defined equations.
- 10 mm pathlength equivalent absorbance values are used and reported for microvolume measurements.

Cuvette IQOQ mode

- The cuvette IQOQ 10 mm option is exclusively for use with the Formula Methods app when running the DeNovix suggested IQOQ procedure. Contact customer support for more information.

16. Fluorescence: Basic Operation

DeNovix Spectrophotometer/Fluorometer software includes both absorbance and fluorescence apps. The fluorescence app icons will appear on the first page of the Home screen for the DS-11 FX and DS-11 FX+ models. The inactive versions of the icons will appear on the second page for DS11 or DS-11+ units when a FX Module USB accessory is not detected.

Activation of **21 CFR Part 11 Compliance Ready Software** affects some aspects of the user interface. Where applicable additional instructions for **21 CFR Mode** operation are provided. Contact DeNovix or your local Distributor to purchase an activation code.

The table below lists the four LEDs included in all FX models. Users must select the appropriate LED for the assay that they choose for quantification.

LEDs	Excitation Filter Range	Emission Filter Range
UV	361 - 389 nm	435 - 485 nm
Blue	442 - 497 nm	514 - 567 nm
Green	490 - 558 nm	565 - 650 nm
Red	613 - 662 nm	664 - 740 nm

Fluorescence Measurements

1. If using the FX Module accessory, connect the module to the DS-11/DS-11+ using one of the three USB ports.
2. Insert a PCR tube pre-filled with the fluorescent solution. Close the cover and tap **Measure**.

Notes:

- *Use clear thin-walled 0.5 mL plastic PCR tubes only*
- *Measure 200 µL volume samples.*





Best Practices

- Ensure all sample concentrations in the thin-walled assay tubes fall within the limits of the assay or reagent kit for accurate results.
- Use 200 µL volumes in a clear thin-walled PCR tube.
- Lower the cover before tapping the measure button.
- Avoid introducing air bubbles into the sample solution when mixing samples.
- Follow assay reagent manufacturers' recommendations regarding temperature, incubation time, and protection from ambient light.

- Follow assay reagent manufacturers' recommendations regarding suggested standard curve concentrations and data analysis.
- Ensure all samples and standards are treated identically in terms of incubation times and temperature.
- Minimize assay tube and solution temperature fluctuations as these may impact the accuracy of the assay. Samples at higher temperatures will generally have lower fluorescence.
- Do not label the side of an assay tube as this could interfere with the sample measurement.

17. Fluorescence: Standard Curve Method Apps

The EasyApps™ listed below are designed using the same basic architecture. Each app includes a choice of four excitation LEDs (UV, Blue, Red, Green) and a variety of assays. The end user is responsible for selecting the proper choice based on the analyte that will be used for quantification.

	Fluoro dsDNA	<ul style="list-style-type: none">•DeNovix dsDNA Broad Range•DeNovix dsDNA High Sensitivity•DeNovix dsDNA Ultra High Sensitivity•Quant-iT™ PicoGreen•Quant-iT™ dsDNA HS•Quant-iT™ dsDNA BR	<ul style="list-style-type: none">•Qubit™ dsDNA BR•Qubit™ dsDNA HS•Quantifluor dsDNA•Quantifluor One dsDNA•Qubit™ 1X dsDNA HS•Qubit™ 1X dsDNA BR
	Fluoro RNA	<ul style="list-style-type: none">•DeNovix RNA Assay•Quant-iT™ RiboGreen•Quant-iT™ RNA HS•Quant-iT™ RNA BR•Qubit™ RNA HS	<ul style="list-style-type: none">•Qubit™ RNA BR•Quantifluor RNA•Quant-iT™ microRNA•Qubit™ microRNA
	Fluoro ssDNA	<ul style="list-style-type: none">•Quant-iT™ OliGreen•Qubit™ ssDNA•Quantifluor ssDNA	
	Fluoro Protein	<ul style="list-style-type: none">•Quant-iT™ Protein•Qubit™ Protein•Qubit™ Protein BR	
	Fluoro Std Assays	<ul style="list-style-type: none">•All entries to be defined by the user	

Quick Protocol

1. Launch the app from the **Home** screen.
2. Select an excitation LED using the drop-down menu on the **Run** screen.
3. Generate a new curve:
 - Insert the standard (200 μ L total assay volume in a thin-walled PCR tube) into the sample holder and lower the cover. Measure at least one replicate for a minimum of 2 standard concentrations.

- Alternatively, import a saved curve or list of sample concentrations
4. Tap the **Samples** radio button.
 - Optional: Enter a sample name and dilution factor to be applied to the reported concentration.
 5. Quantitate a sample using the **Measure** button.

Refer to the manufacturer of the assay reagent for assay specific instructions.

Note: DeNovix and Qubit™ assays will have predefined standard concentrations and specified units.

Run Screen- Assay and Curve Selections

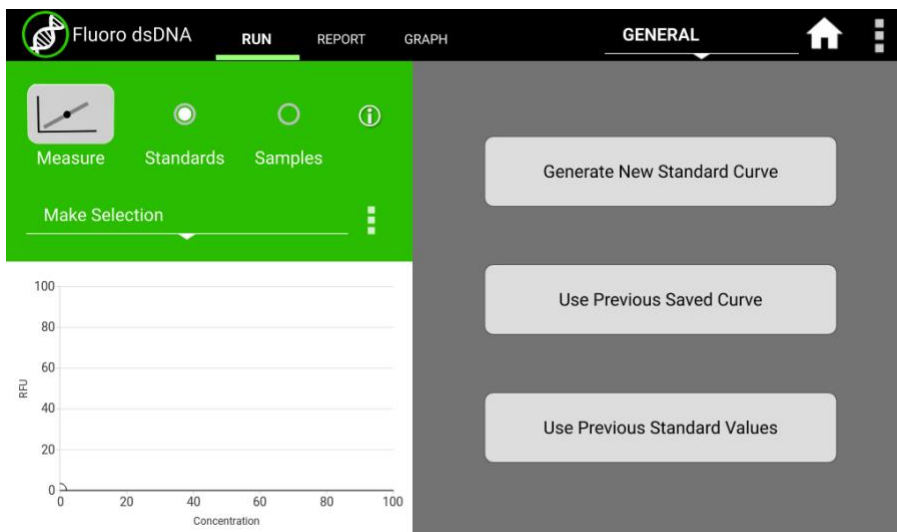

Excitation Source (LED) and Assay Selection

- Select the LED from the drop-down menu in the left panel. The user must choose the appropriate LED for the analyte in use.
- New assays may be entered using the List Add/Edit button.
- User defined assays may be used by all accounts but may be modified or deleted only by the account owner.

Curve Options

Generate New Curve

- Choosing this option will pop-up a dialog window used to enter the concentration values for the standards.
- Verify the concentrations of the standards for the LED / Assay chosen. The standard concentrations for all other assays are determined by the user at the time of the assay.
- Trend line analysis options and concentration units used may be changed using the advanced options button.
 - **Blank:** If selected, the first row in the standards table is used to measure a Blank. The average RFU value of the blank measurements will be subtracted from all standard and sample measurements. If the Blank is not selected, the initial concentration for preconfigured assays will be set to 0.00. This standard is typically the reagent/fluorophore solution without any nucleic acid or protein.
 - **Trend Line:** If selected, the trend line will be forced through the lowest standard concentration. When a Blank is used, the trend line will be forced through the graph origin (0,0).

Use Previous Curve or Std Values

- Choosing this option will pop-up a dialog window with a radio button selector for saved standard curves and saved standard curve concentration lists.
- All modifications to a curve or list are effective **immediately**. It is important to save the selection with a new name prior to making any changes if you do not want to modify the original curve or standards list. Changes to a curve do not affect previously measured samples.
- Although all saved lists and saved curves are available for use by all accounts, only the account holder may modify the selection.

Run Screen- Standard Curve View

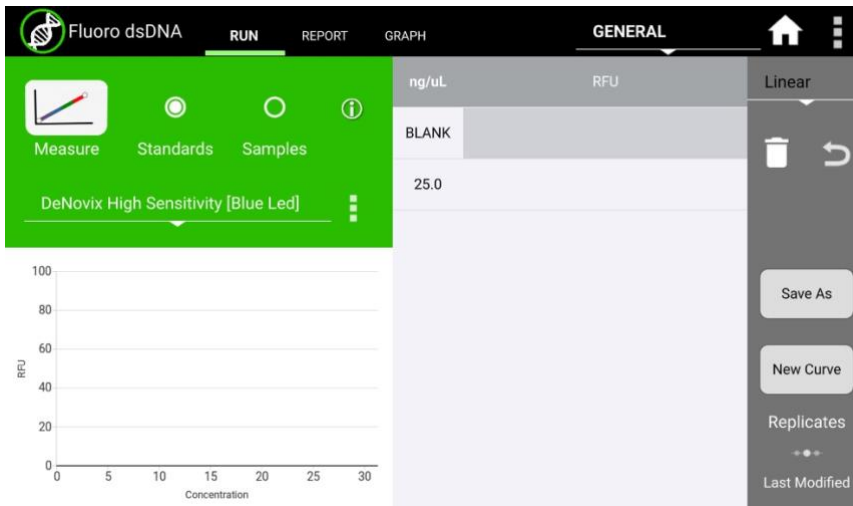

- The **Stds** button will pop-up the Edit Concentrations for Standard Curve window.
- The **Delete and Undo** icons are used to manage the RFU values within the table.
- The **Save** button will pop-up the Save Values window. Either concentration values or concentration values with the associated RFU values may be saved.
- The **New Curve** button is used to generate a new curve or load a previously saved curve. All sample data generated using the Samples radio button will be automatically saved and accessible using the Data app.
- The **Replicates** arrow button enables the use of up to three replicate measurements per standard concentration. The average of the replicates will be used to generate the trend line.

Run Screen- Sample Results View

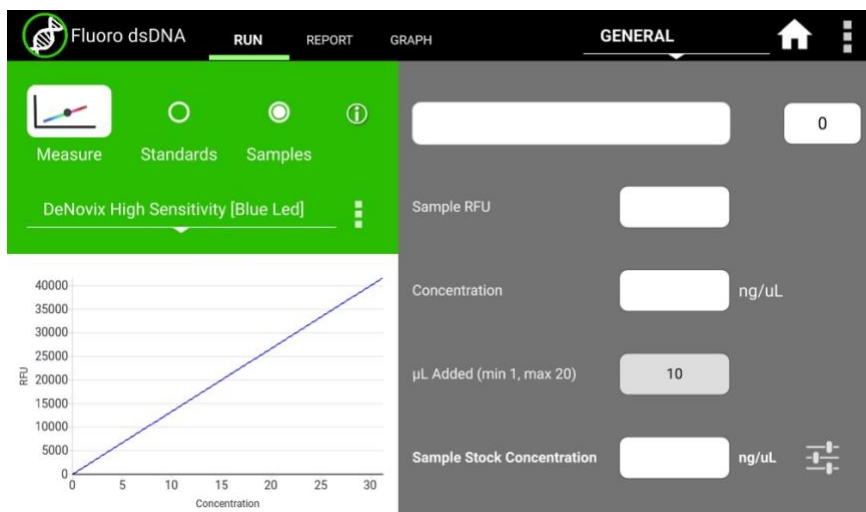

- Use the **Samples** radio button to display the measurement results view.
- The samples **Measure** button will be disabled until one replicate of at least two standards are measured using the standard curve view.
- The **Concentration from Curve** results are calculated directly from the standard curve trend line. Results are reported in terms of the units used to derive the trend line.
- The **Optional Dilution Factor** (or the **µL Added** value for Qubit™ assays) will be applied as a multiplier to the Concentration from Curve value and the result reported in the Sample Stock Concentration field.
- The **Sample Stock Concentration** results are reported in terms of the units selected by the user. The value saved in Report will be displayed in terms of the units in use at the time of the measurement.

New Standard Curve Assays/Methods

Each new method requires a unique name. In addition, the following parameters must be defined:

Excitation Source

- Use **LED Radio** buttons to select the excitation source.
- The **LED Wizard** may be used to determine a compatible excitation source if not known. The software will make a measurement using each of the four excitation sources and will report the associated RFU in the color-coded boxes.
- Some fluorophores do not exhibit significant fluorescence unless bound to a protein or nucleic acid. It may be necessary to set up an assay reaction to best use the LED Wizard.

- The standard curve assay methods use one excitation source to determine the concentration of a sample based upon the RFU measured using the corresponding emission filter set.

Advanced Options

- Use the **Advanced Option** buttons to set both the Trend Line/Blank selections as well as the standard curve units.

Although all accounts may use any saved method, only the method account holder or an administrator may modify or delete the new method.

18. Basic Fluorometer App



Basic Fluorometer

This app enables DeNovix systems to be used as a versatile fluorometer for applications such as dye QC checks and assay development. The app is especially useful for fluorophores with significant Stoke shifts as it allows the user to excite a sample with one LED and obtain RFU results from multiple emission channels.

Quick Protocol

1. Launch the app from the **Home** screen.
2. Select an excitation LED using the radio buttons.
3. Optional: Create and Save a used defined method (LED selection and user defined assay name).
4. Optional: Enter a sample name.
5. Tap the **Measure** button.

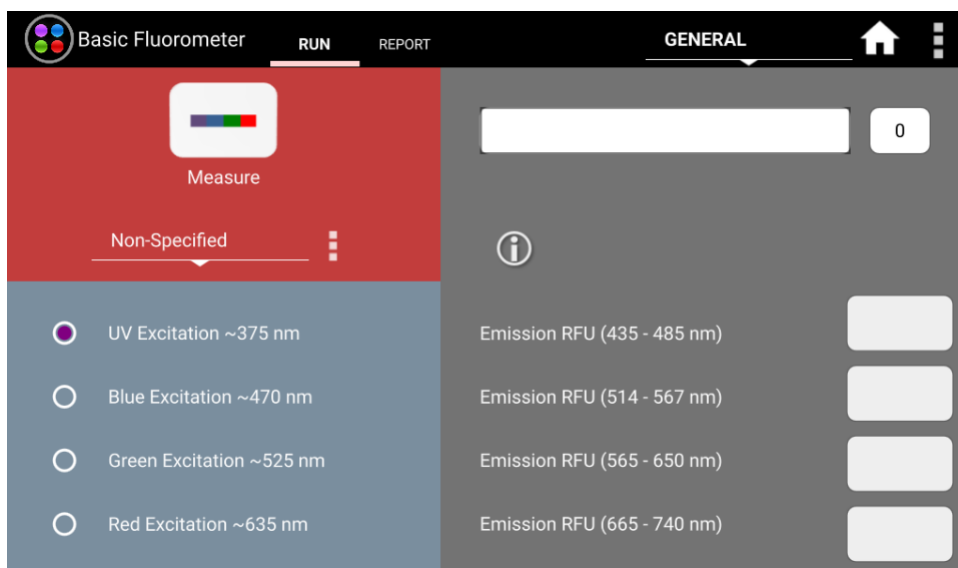

Excitation Selection and Emission Results

- Select an excitation source (LED) or LED plus fluorophore combination.
- The selected LED is the **only** excitation source used during a measurement. However, the emission RFU will be collected for each longer wavelength emission filter set.
 - For example, if the blue LED is selected, the emission results for the blue, green and red channels will be reported. If the green LED is selected, only the green and red channel results will be reported.
- User defined fluorophores may be entered using the List Add/Edit button.

- The Add button will pop-up a window that includes a LED Wizard. Tapping the Wizard button will result in the sample being excited by each LED and the RFU measured by the corresponding detector. The user can select the LED most compatible with the method.

19. Data Export and Print Options

Export Options

From the Report or Graph screen, sample data may be exported via email, to network printers, label printers, network folders or saved to a FAT32 formatted USB flash drive. Export options vary depending on the destination. For instance, the full contents of a csv file cannot be sent to a network printer.

Export Formats

CSV file

- The default .csv file format for each absorbance measurement app includes all absorbance vs wavelength data for the app specific measurement wavelength range as well as the calculated data displayed on the app Report screen. The csv file can be saved to USB, saved to a network folder or emailed.
- To open an exported .csv file on a computer, the DeNovix instrument and the computer must **both** be set to use either period or comma number formats. The instrument's number format is determined by the language selected in the Settings app.

PDF Report

- A pdf report file can be generated for each measurement app. The pdf can be saved to USB, emailed, printed to a network printer or saved to a network folder.

Screenshots

- Use the overflow menu to capture the active screen. This is a convenient way to export spectral graphs from the Graphs page.
- The png file may be exported by email, saved to a network folder, saved to a USB drive or printed to a network printer.

Export Via Email

- Screen captures, .csv files and pdf summary reports may be exported via email.
- Use the User Accounts app **Address Book** to save frequently used email addresses.
- It is recommended that a new, dedicated POP3 Gmail or Outlook account be used for all outgoing email from the DS-11. This type of account works very well with the instrument's operating system and prevents personal incoming email from being stored on the unit.

Export to a Network Folder

The instrument can export to SMB network folders connected to the same network as the instrument. For best results connect to the network through an ethernet connection, especially if exporting pdfs and images. See Settings for more information.

USB

- Screen captures, pdf reports and data .csv files may be saved to a FAT32 formatted USB flash drive.
- There are two USB ports on the back of the instrument and one on the side although only one storage device is recognized at a time. The two additional ports may be used for the FX Module accessory, label printers, keyboards, mouse and barcode readers.
- DO NOT USE INSTRUMENT USB PORTS TO CHARGE OTHER DEVICES.
- DO NOT CONNECT MOBILE PHONES TO USB PORTS.

Print Options

- The DS-11 can print to networked printers or to select label printers. All label print-outs are in black and white. See our website for a list of supported label printers and supported label sizes.

Network Printers

- Screenshots and pdf summary reports may be printed to network printers.
- Use the Settings app to search for and add printers. Printers that are configured as driverless CUPS printing are supported.
- Please contact DeNovix or your local distributor for a list of recommended printers if your current printer is not recognized on the network.

20. Utility Apps and Functions



User
Accounts



Data



Settings



Updater

Standard Mode Instructions

This section describes functionality for instruments that are not running in 21 CFR Mode. Please see the 21 CFR Utility Apps and Functions section for details about how the apps are configured in that mode.

User Accounts App

The User Accounts app allows users to create and manage individual accounts. Users can adjust their default settings. Accounts are also used as a means of segregating data when performing searches in the Data app.

App Structure

Accounts are listed in the left pane of the screen. A menu of app function options is presented in the action bar, where the selected option is highlighted with a blue background.

Select a user account from the dropdown list in the top grey bar and select an option to edit: Profile, Report Emails, File Share, and Defaults.

App Functions

The basic functions controlled using the Account app are as follows:

- Adding and deleting accounts
- Managing passwords for accounts
- Managing email addresses associated with an account
- Setting account specific app protocol preferences

Default System Accounts

There are two preconfigured system accounts built into the software - the General Account and the Primary Administrator Account. These accounts may not be deleted.

Primary Administrator

- This account is used to manage instrument settings. It is not used within the measurement applications.
- The primary administrator account is not initially password protected. A password may be applied at any time.

General Account

- This account is used as the default selection for all apps each time an app is opened. This account may not be password protected or deleted.

User Account Types

There are two types of accounts that may be added, edited or deleted.

User Added Standard Accounts

Any user may add a standard level account. It is not necessary to select an account before adding a new standard account.

Standard accounts may only modify or delete protocols or emails created from within their account.

User Added Administrator Accounts

- An administrator level account may only be created by another administrator. The primary administrator or another existing administrator account must be highlighted in order to enable the adding of a new administrator.
- Administrator accounts may modify or delete user entries of any sort created from within any account. A drop-down menu is used to select the desired account.
- Administrators may change the password for any account as well as delete any account.

Account Passwords

- Passwords are optional for all added administrator or standard user accounts.
- Contact the holder of an administrator account if a standard user account password is forgotten.
- Contact DeNovix customer support or your local distributor if the Primary Administrator password is forgotten. Please have the serial number of the instrument available when requesting help for the Primary Administrator password reset.

Deleting an Account

- When an account is deleted, all protocols and custom report formats created by that account are reassigned to the General Account.
- The account specific saved data will also be permanently removed from the instrument at the time the account is deleted.

Tab - Email Addresses

Multiple "to" email addresses for exporting results may be set up for each account. The nickname is used in the drop-down list presented on an export destination dialog box.

Tab - Defaults

Some application specific default settings may be defined on a per account basis. Launch the Accounts app from the Home screen and then use the drop-down menus to select the account, the app and the setting of interest.

Note: The default selections for the General Account may not be modified.

Data App

This app allows the user to search for past data by user account, date or application. Data can then be added to the Report and Graph screens for review and export. Previous results can be deleted from within the Data app.

Search Options

- Data is automatically filtered based upon the Account selected using the tab on the top action bar.
- Once the filter criteria have been selected, tap the **Search** button at the bottom of the screen. Tap any column header to sort the results list.
- Highlight the sample(s) of interest and tap the **Add to Report** button to include the samples on the Report and Graph screens. Blank measurements may be included in the list but will not provide any absorbance data.
- Data from the same app type for the samples to be added to the Report or Graph screens. Clear the previous selects to find data from a different application.
 - Note: The Data app does not include a Graph screen for fluorescence apps.

Exporting and Deleting Data

- All data is automatically saved to the DS-11 onboard computer database at the time of measurement.
- The **Export Selected Samples** function available from the Report and Graph screen are the same options available in the Report and Graphs screens discussed in the previous Data Export and Print options section.
 - When the export function is used, the data is **not** deleted from the database and can be accessed using the Data app.
 - Only one Kinetics run at a time may be added to a Report for export from the Data app.
- The **Delete** function available from the Report and Graph screen in the Data app.
- When the **Delete** function is used, the data is *permanently* deleted from the instrument database and cannot be restored to the instrument.

- The storage capability of the DS-11 Series is sufficient for several years of data for a lab with average use.

Settings App

The Settings app allows General accounts to see basic system information. Administrator accounts can access the Permissions tab to adjust access to system settings. The Settings app provides access to the following functions and information:

System Info

View software and firmware versions, IP addresses, current language and hostname.

Date/Time

Select manual or automatic date and time options.

Language













Select the language of operation for the device. Not all languages are fully translated. Setting the language also determines whether a period or a comma is used for the decimal place.

Network Information

The Wi-Fi and Ethernet MAC addresses and IP addresses can be found under this setting.

Permissions

Administrator level accounts can use Permissions to set access to the Settings app tabs for general level accounts.

<input checked="" type="checkbox"/>	 System Info	<input checked="" type="checkbox"/>	 Date/Time
<input checked="" type="checkbox"/>	 Language	<input checked="" type="checkbox"/>	 Network Information
<input type="checkbox"/>	 Permissions	<input checked="" type="checkbox"/>	 Sound
<input checked="" type="checkbox"/>	 Storage	<input checked="" type="checkbox"/>	 WiFi
<input checked="" type="checkbox"/>	 Ethernet	<input checked="" type="checkbox"/>	 Display
<input checked="" type="checkbox"/>	 Network Folders	<input checked="" type="checkbox"/>	 Network Printing
<input checked="" type="checkbox"/>	 Email		

21 CFR Mode: Administrators can disable the “Discard” button from this screen if desired.

Sound

Play a test sound.

Storage

Displays current storage statistics.

Wi-Fi

Turn Wi-Fi on or off and connect/disconnect from a network.

Connect the instrument to a 2.4 GHz or 5 GHz network.

Select the country where the unit is installed in order to ensure the Wi-Fi radio uses the correct frequency bands.

DeNovix instruments are compatible with eduroam using login credentials provided by your institution. See Technical Note 225 on denovix.com for a step-by-step guide to connect.

Ethernet

Ensure that the Ethernet cable is connected.

Tap the Edit button to configure Ethernet connection.

Contact your local IT department if additional help setting up Wi-Fi or Ethernet is needed.

Display

Includes controls for screen brightness and when the screen sleeps.

Network Folder

The instrument can export to SMB network folders connected to the same network as the instrument. For best results connect to the network through an ethernet connection, especially if exporting pdfs and images.

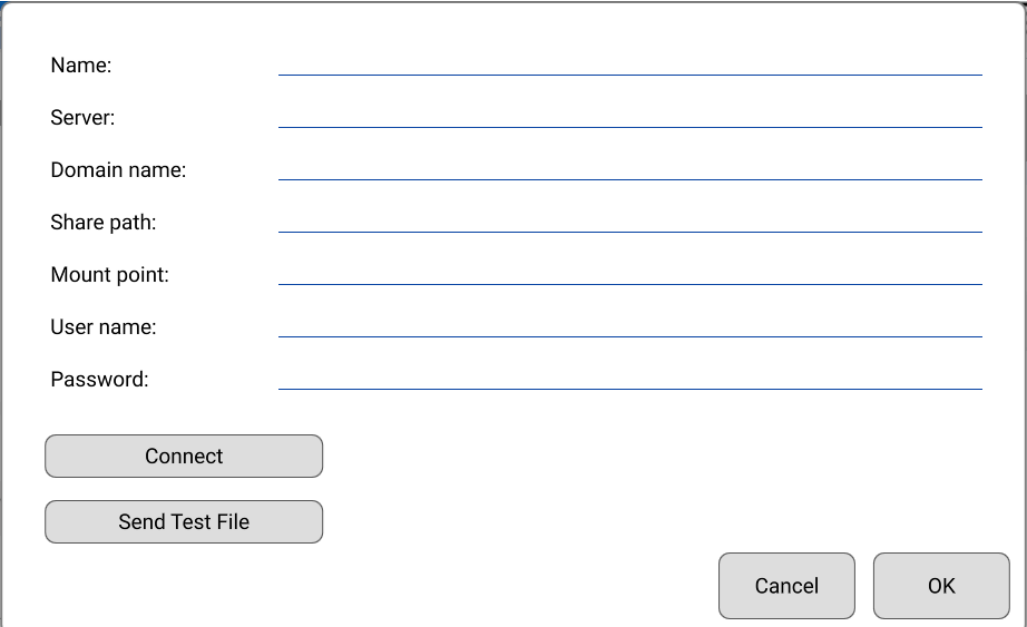

The image shows a dialog box for configuring a network folder. It contains the following fields and buttons:

- Name: _____
- Server: _____
- Domain name: _____
- Share path: _____
- Mount point: _____
- User name: _____
- Password: _____
- Buttons: Connect, Send Test File, Cancel, OK

Enter the following information. See DeNovix Tech Note 122 or your IT Department for additional help.

- **Name** - Create a name for your network connection.
- **Server** - The IP address of computer or server where the shared folder is located. The IP can be found in Windows Network Status under “Properties” or by entering **ipconfig** at the Windows command prompt.
- **Domain name** - The domain name when the shared folder resides. From a windows command prompt enter **echo %userdomain%**. Do not include slashes or backslashes.
- **Share path** - The share name of the shared folder. In Windows, find this by right clicking on the shared folder and viewing the properties. The share name should be a single word. No slashes or backslashes.

The example below shows a correctly shared folder.

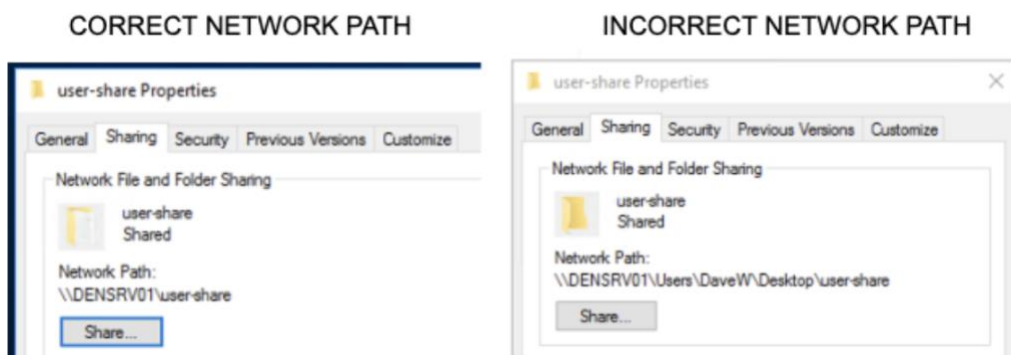

- **Mount point (optional)** -The path to a subfolder within the main shared folder. Example input **sub1/sub2** is sub1 is a folder inside the main shared folder and sub2 is within folder sub1.
- **User name** - The username accessing the share. No slashes or backslashes.
- **Password** - Password of the User name account.

Press **Connect** to connect to the network folder. Press **Send Test File** to transfer a time stamped text file **denovix.txt** to the network folder.

Network Printing

Search and add compatible network printers for easy export of hard copy reports.

Email

Email Set-Up

- Ensure that the instrument is connected to Wi-Fi or Ethernet.
- Launch the Settings app and navigate to the Email section on the left scroll menu.
- Enable the **POP3** option on your Email configuration. Do not use an IMAP account as messages from IMAP accounts could occupy a significant amount of the instrument's memory.

See Technical Note 205 on denovix.com for a step by step walkthrough of email setup. Refer to your IT support group and DS-11 Series Technical Notes on denovix.com if additional assistance is required.

Updater App

Updater is used to update system software and firmware to the most current available versions. Updates may be downloaded using the Updater app when connected to Ethernet or Wi-Fi. An Ethernet connection is recommended for software updates.

Updates may also download to a FAT32 formatted USB drive from denovix.com. Download the update file to the root directly of the USB drive. Do not change the file name. Insert the USB drive in the device and then launch the Updater app. Follow the onscreen instructions to update.

Note: The update process may require one or more automatic system reboots.

21. 21 CFR App



21 CFR

Compliance Ready Software

DeNovix 21 CFR Part 11 Compliance Ready Software is available for activation on DS-11 Series, QFX and DS-C instruments. An activation code is required and can be purchased from DeNovix or a DeNovix distributor. Once activated, 21 CFR Mode provides a suite of seamless, integrated controls for electronically signing records, managing user accounts, configuring the organization and accessing the audit trail. The software enables the following:

- A convenient configuration wizard for easy set up and customization during activation.
- User login with unique User ID and password for each user.
- Operation as a closed system with a single, continuous period of controlled system access.
- Users review results and electronically sign records while logged in. Records can be electronically signed with a Signature Meaning that is associated with the user's assigned Role.
- Prompt export (and back up) of electronically signed records to a second location when completing a measurement session.
- Export of human readable pdf reports and optional raw data such as csv files. The pdf report includes details of each electronic signature associated with a record.
- A user interface for viewing stored information but no ability to directly access and alter electronically stored data.
- Administrator tools to customize and manage the organization's Roles, Signature Levels and Signature Meanings.
- Administrator tools for User Account management including Role assignment, activation, deactivation, name changes and password resets.
- An Audit Trail function to automatically log system events and user activities in a database. If audited, System Administrators can easily search the Audit Trail and export a human readable .csv report.

Activation Wizard Overview

The activation wizard is a step-by-step procedure for setting up an instrument to comply with your organization's needs. Default valves are included but are fully configurable during activation. 21 CFR Mode:

- Each user is assigned to Role
- Each Role has a Signature Level which establishes a rank in the organization
- A set of Signature Meanings must be defined (tested, rejected, approved, etc.)
- Roles are linked to one or more Signature Meanings, meaning that any User who is assigned to a Role can electronically sign a record with one of the available signature meanings.
- Once the organization rules are configured, each user is assigned to a Role. This establishes the signature privileges of each user.

Activation Wizard 1/7 - Administrator Account

To begin, open the 21 CFR app and select an Administrator level account from the Account selector at the top of the screen. If a user created Administrator account isn't selected or none exists, the user is prompted to create a new Administrator account.

When 21 CFR Mode is activated, the open access accounts "General" and "Primary Admin" are deactivated.

Activation Wizard 2/7 – Enter Activation Code

Enter the twenty-digit activation code and press Apply Code.

Activation Code 2/7

21 CFR Part 11 compliance ready software can be activated on this instrument. Please enter your activation code. To purchase an activation license, US customers should contact DeNovix and international customers should contact their local DeNovix Distributor. Please include the serial number in your request.

Enter Code: _____ - _____ - _____ - _____ - _____

Activation Wizard 3/7 - Roles

Users will be assigned to a Role in the final step of activation. In this step set up the Roles for the organization. Each Role includes a value for Signature level. The Signature Level value establishes a hierarchy in the organization. Users can view data for users at their Signature Level and below. But they cannot view data for Roles with higher Signature Level number.

Define the Roles for the organization. These may be changed later by a System Administrator

Role	Signature Level
System Administrator	1000
Principle Investigator	900
Lab Manager	700
Sr. Scientist	500
Scientist	400
Sr. Technician	300



Next

Activation Wizard 4/7 – Signature Meaning

Each User, through their assigned Role, will be able to electronically sign records with the Signature Meanings as defined in this table. Configure the Signature Meanings as required for the organization but using the add, edit and delete icons. At least one Signature Meaning must exist.

Configure Organization (Signature Meaning) 4/7

Define the signature Meanings for the organization. Permitted Signature Meanings will be assigned to Roles in the next step of configuration. These may be changed later by a System Administrator.

Signature Meaning
Tested
Reviewed
Approved
Released
Rejected

Previous Next

Activation Wizard 5/7 – Role-Signature Meaning Linking

In this step, set the Signature Meanings for each Role. Select a Role from the table and then check Include to allow that Role to electronically sign records with that particular Signature Meaning. In the example shown, the Sr. Technician Role can e-Sign records with Tested, Reviewed and Edit sample name/description Signature Meanings. Any Role must be linked to at least one Signature Meaning.

Configure Organization (Role - Signature Meaning) 5/7

Select a Role and then check boxes to assign the Signature Meanings permitted for each Role. These may be changed later by a System Administrator.

Role	Signature Meaning	Include?
System Administrator	Tested	<input checked="" type="checkbox"/>
Principle Investigator	Reviewed	<input checked="" type="checkbox"/>
Lab Manager	Approved	<input type="checkbox"/>
Sr. Scientist	Released	<input type="checkbox"/>
Scientist	Rejected	<input type="checkbox"/>
Sr. Technician	Edit sample name/description	<input checked="" type="checkbox"/>

Activation Wizard 6/7 – Password Rules

Set password rules as desired for the organization. Some requirements are optional. Minimum password length and account locking after failed attempts to login are requirements of 21 CFR Part 11 compliant software.

Configure Password Rules 6/7

Set the password rules for the organization

Rule	Required	Quantity
Minimum password length	<input checked="" type="checkbox"/>	6
Require special character	<input type="checkbox"/>	0
Require capital letter	<input checked="" type="checkbox"/>	1
Require numeric character	<input checked="" type="checkbox"/>	1
passwords automatically expire (days)	<input checked="" type="checkbox"/>	90
maximum number of login failures before account is locked	<input checked="" type="checkbox"/>	5

Activation Wizard 7/7 – Existing Users



The final step of the Activation Wizard is to complete the user records for any existing user accounts that are on the system. Each user must have a User ID, First Name, Last Name, Role and a temporary password set in order to complete the wizard. Edit user accounts by selecting them from the list and then using the edit icon.

Note: This is last opportunity to delete existing user accounts. After 21 CFR activation is completed, user accounts may be deactivated, but they may not be deleted.

Existing Users 7/7

Select a Role and then check boxes to assign the Signature Meanings permitted for each Role. These may be changed later by a System Administrator.

User ID	First Name	Last Name	Role	Password	Complete?
CFRAdmin	James	Smith	System Administrator	Done	<input checked="" type="checkbox"/>
Ashelby	Arthur	Shelby	Lab Manager	Done	<input checked="" type="checkbox"/>
APowers	Austin	Powers	System Administrator	Done	<input checked="" type="checkbox"/>

Measurements and Electronic Signed Records

DeNovix 21 CFR compliance ready software enables users to electronically sign results according to their signature level and permissions established by a system administrator. Organizations are responsible for establishing standard operating procedures to ensure users and the organization comply with all facets of the 21 CFR regulations.

Blanks and Sample Measurements must be electronically signed.

Follow app specific instructions for creating methods or generating standard curves if applicable.

After each measurement, the user must choose to Sign or Discard a result.

- **Discard:** The result is not saved. SOPs should be established related to the use of discard to avoid 'testing into compliance' scenarios. The Discard button may be disabled by an Administrator account using the Permissions tab in the Settings app.
- **Sign:** With the first measurement of each session, the user must verify the user ID and enter a correct password. Subsequent measurements are signed with the user ID only.

Measure additional samples until ready to end the session.

DeNovix recommends that the users immediately export signed records and reports when ending a session. As a reminder, at the end of each measurement session the user will be asked if they would like to generate a 21 CFR Report for the session.

The 21 CFR Report is a non-editable, human-readable pdf report summarizing data from all measurements within a session (or selected results within a session or the Data app).

The report includes result information, electronic signature details for each result and the MD5 (hash) value of a csv file of all data included in the report.

21 CFR Reports and csv should be backed up to a secondary location (USB drive, network folder, hard copy to printer, etc.). The system administrator is responsible for ensuring systems are properly backed up.

Standard curve replicates do not need to be signed. The values of all replicates used to generate a standard curve are saved with each result. The user signs the measurement which binds the sample result to the curve used to generate it.

Audit Trail

DeNovix 21 CFR software continually creates an Audit Trail which is a time-stamped log of events and changes that take place in the system throughout the life of the instrument. Administrators can search the audit trail to filter the results by date, Event Type, User ID and Signature Meaning.

The screenshot shows the 'Audit Trail Search' interface. It features a search bar at the top with a magnifying glass icon and the text 'SEARCH'. Below the search bar are several filter options: 'Start Date' and 'End Date' with calendar icons, 'Event Type - All', 'User ID - All', and 'Signature Type - All', each with a dropdown arrow and a search icon. A 'Search' button with a magnifying glass icon is located at the bottom left. The main area displays a table of results with the following columns: Account, Event, Signature, and Date. The table contains several rows of data, including events like 'Signature Released', 'Record Management', and 'Signature Approved'.

Account	Event	Signature	Date
CFRAdmin	Signature	Released	2020 Aug 4 16:12
CFRAdmin	Record Management		2020 Aug 4 16:11
CFRAdmin	Signature	Approved	2020 Aug 4 16:11
CFRAdmin	Record Management		2020 Aug 4 16:11
CFRAdmin	Signature	Approved	2020 Aug 4 16:10
CFRAdmin	Signature	Approved	2020 Aug 4 16:10
CFRAdmin	Record Management		2020 Aug 4 16:05
CFRAdmin	Record Management		2020 Aug 4 16:03

Event types tracked include Signature, System, User Account, Record Management and Application/Machine errors. Some examples of logged events are the electronic signature of a result, deactivating a user, a failed login attempt, exporting a result and archiving a record. This list is only representative and is not a complete list of all actions logged.

Set the filters as desired and press Search to update the result list. Select records and press "Add to Report". Move to the Report Tab to see additional information about each audit trail entry. To export a copy of the Audit Trail as a .csv file, select records, press the export icon and select the destination.

The screenshot shows the 'Audit Trail List' interface. It features a 'REPORT' tab at the top, a 'Clear' button, and a share icon. The main area displays a table of results with the following columns: Account, Result ID, Event, Signature, Comment, and Date. The table contains several rows of data, including events like 'System', 'Record Management', and 'Signature Approved'.

Account	Result ID	Event	Signature	Comment	Date
CFRAdmin		System		Update user information CFRAdmin, John, Smith, System Administrator Exported	2020 Aug 4 15:43
CFRAdmin	0426620200804160249	Record Management		Exported	2020 Aug 4 16:03
CFRAdmin	0426620200804160452	Record Management		Exported	2020 Aug 4 16:05
CFRAdmin	0426620200804160452	Signature	Approved		2020 Aug 4 16:10
CFRAdmin	0426620200804160452	Signature	Approved		2020 Aug 4 16:10
CFRAdmin	0426620200804160452	Record Management		Exported	2020 Aug 4 16:11
CFRAdmin	0426620200804160452	Signature	Approved		2020 Aug 4 16:11
CFRAdmin	0426620200804160452	Record Management		Exported	2020 Aug 4 16:11

IMPORTANT NOTE FOR SYSTEM ADMINISTRATORS!

The Audit Trail should be backed up on a regular basis by a System Administrator. DeNovix recommends that organizations establish procedures to regularly export the full Audit Trail log via .csv to a backup file location.

Archiving

Results that have been previously exported from the instrument may be permanently deleted through use of the Archiving function in the 21 CFR app. This is the only mechanism for removing data from the instrument. Prior to removal, the Administrator should confirm records that will be removed have been properly backed up to another location. Use the Data app to export additional copies of the electronically signed results prior to archiving. **Archiving immediately and permanently deletes all data associated with the signed record. Do not archive a record before confirming a secure copy of the record exists in a secondary location or has been properly managed according to the organization's records retention policies.** All Archiving events are captured in the Audit Trail database.

Filter the results by date, App, User ID and Signature Type as desired. Touch Search to update the search results. Select desired results and then Add to Report.

Signature/UserID	Sample	Date
Tested B		2021-4-14 14:19
Tested B		2021-4-14 14:18
Tested B		2021-4-14 14:18
Tested B		2021-4-14 14:13
Tested B		2021-4-14 14:12
Tested B	BLANK	2021-4-14 14:11
Rejected B		2021-4-14 13:55

The Report tab view shows if a result has been previously exported from the system. Only results that have been exported can be selected for archiving. Touch the delete icon to initiate archiving. The system Administrator must enter their password to complete archiving. **The archived records are immediately deleted. Since the record has been previously exported, an additional backup copy is not created at the time of archiving.**

Exported	Date&Time	Signature/UserID	App	Sample ID	Sample Name
<input checked="" type="checkbox"/>	2021-4-14 15:51	Approved B	dsDNA	6942020210414155102	BLANK
<input checked="" type="checkbox"/>	2021-4-14 15:51	Tested B	dsDNA	6942020210414155134	
<input checked="" type="checkbox"/>	2021-4-14 15:51	Tested B	dsDNA	6942020210414155152	
<input checked="" type="checkbox"/>	2021-4-14 15:52	Released B	dsDNA	6942020210414155219	
<input checked="" type="checkbox"/>	2021-4-14 15:52	Tested B	dsDNA	6942020210414155241	

22. 21 CFR Mode - Utility Apps and Functions



21 CFR Mode Instructions

This section describes functionality for instruments that are running in 21 CFR Mode. Please see the Utility Apps and Functions section for details about how the apps are configured in Standard mode.

User Accounts App

System Administrators use the User Accounts app to create and manage user accounts on the device. The app is also used for selecting roles, deactivating users, setting temporary passwords and changing account information. Each user is required to have a unique User ID and password that meets the organization's password rules set in the 21 CFR App. All User Account changes are captured in the 21 CFR Audit Trail data.

IMPORTANT: Organizations are responsible for following the strict security requirements of 21 CFR Part 11 regulations. DeNovix software enables a method of compliance, but organizations are responsible for establishing and following procedures to ensure compliance.

App Structure

User accounts are listed in the left pane of the screen. Within a user's own account, tabs in the right pane allow access to User Profile, Emails, Network Folders and Default settings.

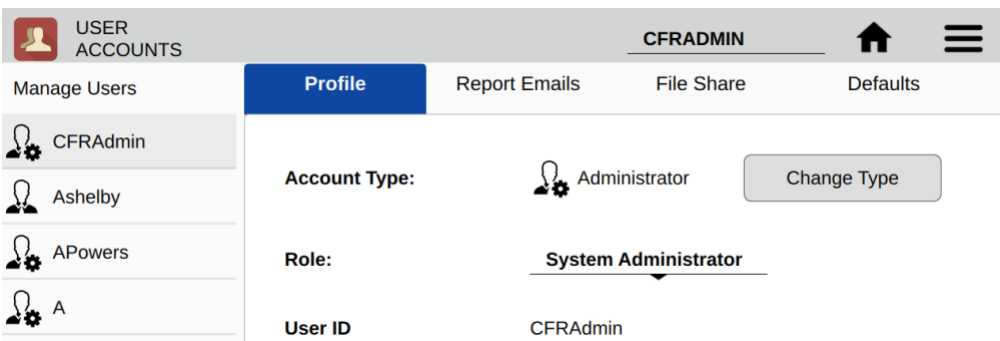

Administrators can access the Profile tab of other users by selecting that user from the list in the left pane.

The screenshot shows the 'USER ACCOUNTS' interface. At the top, there's a header with 'USER ACCOUNTS' on the left, 'CFRADMIN' in the center, and a home icon and menu icon on the right. Below the header is a sidebar with 'Manage Users' and a list of users: CFRAdmin, Ashelby (selected), APowers, A, and Aa. A plus sign button is at the bottom of the sidebar. The main content area is titled 'Profile' and shows the details for the selected user, Ashelby. The details include:

- Account Type:** User (with a 'Change Type' button)
- Role:** Lab Manager (with a dropdown arrow)
- User ID:** Ashelby
- First Name:** Arthur (with a 'Change' button)
- Last Name:** Shelby (with a 'Change' button)
- Temporary Password:** (with a button)
- Deactivate:** (with a button)

 At the bottom of the profile card, it says 'Passwords are required.'

App Functions

Administrators have the following functions within the User Accounts app.

- Add accounts
- Set Account Type
- Assign Role
- Change first name or last name
- Set Temporary Passwords
- Deactivate / Reactivate accounts

Adding Accounts

Choose the + symbol from the left column to add a new user. Assign a User ID and the user's information. Create a temporary password for the new user. All users must have a unique User ID.

Account Type

- **User** – This account type has full access to count apps and permitted utility apps. User account types do not have any access to Administrator level system settings. A user may change first name, last name or password of his/her own account, but the user cannot change anything related to other user accounts.
- **Administrator** – This user type has full access and control over all system settings. At least one Administrator account must always be active in 21 CFR Mode. All Administrator accounts have the same administrative controls on the device.

Role

Each user must be assigned to an available Role as defined in the 21 CFR App. See 21 CFR App section for configuration details.

Account Passwords

- Passwords are required for all Users.
- Password must follow the organization rules set in the 21 CFR App (special characters, length, etc.)
- A user may not reuse a password they have previously used.
- If a user is unsuccessful logging in over a set number of times (set in 21 CFR app), the account is locked. An administrator can set a temporary password to unlock the account.
- Organizations are responsible for establishing password security procedures to ensure compliance with 21 CFR Part 11 requirements.
- Contact DeNovix customer support or your local distributor if the sole Administrator password is forgotten. Please have the serial number of the instrument available when requesting help for the reset.

Deactivate / Reactivate an Account

User accounts may be deactivated by an Administrator. Per 21 CFR Part 11 guidelines, a user account may not be deleted. User activation/deactivation is tracked in the Audit Trail.

Tab - Email Addresses

Multiple “to” email addresses for exporting results may be set up for each account. The nickname is used in the drop-down list presented on an export destination dialog box.

Tab - Defaults

Some application specific default settings may be defined on a per account basis. Launch the Accounts app from the Home screen and then use the drop-down menus to select the account, the app and the setting of interest.

Note: The default selections for the General Account may not be modified.

Data App

This app allows the user to search for past data by user, date or application. Data can then be added to the Report and Graph screens for review and export.

Data may be filtered in the following ways from within 21 CFR software:

- App, Export status, User ID, Signature Type, date
- Once the filter criteria have been selected, tap the **Search** button at the bottom of the screen. Tap any column header to sort the results list.
- Highlight the sample(s) of interest and tap the **Add to Report** button to include the samples on Results tab pages.
- All data must be from the same app type for the samples to be added to the Report tab.
- Features and functions previously described for the Result screens apply to the corresponding Data App Report screens.

Export

All electronically signed data is automatically saved to the onboard memory at the time of measurement and may be exported as described in the previous section.

When the export function is used data is not deleted.

Delete

The Delete function is not active for instruments in 21 CFR Mode. Data can only be archived from the system by an Administrator through the 21 CFR app.

Settings App

See Settings App section in Utility Apps and Functions.

Updater App

This app can be opened by Administrator level user accounts when in 21 CFR Mode. Updater is used to update system software and firmware to the most current available versions. Updates may be downloaded using the Updater app when connected to Ethernet or Wi-Fi. An Ethernet connection is recommended for software updates.

Updates may also be downloaded to a FAT32 formatted USB drive from denovix.com. Download the update file to the root directly of the USB drive (do not change the file name). Insert the USB drive in the device and then launch the Updater app. Follow the onscreen instructions to update.

Note: The update process may require one or more automatic system reboots.

23. Lab Tool Apps



Calculators



Timer



ScreenLocker

Calculator App

Three calculators are included within the app. Use the tabs in the top action bar to navigate between the options.

Oligo Calculator

This calculator analyzes a user input ssDNA or RNA sequence of interest.

- *Outputs include:*
 - *Length*
 - *Molecular Weight (g/mol)*
 - *GC Content*
 - *Mass Extinction Coefficient ($\mu\text{g}/\text{OD}$ @260 nm): This result may be copied and pasted into the Factor Input field used for nucleic acid concentration calculations in both the ssDNA and the Microarray apps.*
 - *Melting Temp: For sequences up to 13 nucleotides, the equation used is $T_m = (wA+xT) * 2 + (yG+zC) * 4$ where w,x,y,z are the number of the bases A,T,G,C in the sequence. For sequences longer than 13 nucleotides, the equation used is $T_m = 64.9 + 41 * (yG+zC - 16.4) / (wA+xT+yG+zC)$. Both equations assume that the annealing occurs under the standard conditions of 50 nM primer, 50 mM Na⁺, and pH 7.0.*

Scientific Calculator

Use this calculator for standard mathematical and scientific functions.

Dilution Calculator

This calculator is a useful tool to calculate how much of a stock solution should be added to a buffer solution to result in a final specified solution concentration.

- Both molar and mass units are available. However, conversions between the two types of units are not enabled.

Timer App

This app is a lab tool that allows a user to set two independent timers.

- At the end of a specified period, an alarm will sound.
- Push the **Off** button to silence the alarm.
- The Timer will work in the background while other measurement apps are in use as well as when the screen is in the dark screen saver mode.

ScreenLocker

Launch the ScreenLocker app from the Home screen prior to cleaning the touch screen. This will disable swiping motions from activating other software activities. Tap the home button to exit.

24. Maintenance

Cleaning

Routine	<ol style="list-style-type: none">1. Pipette 2 μL of dH_2O onto the bottom sample surface. Lower the upper arm. Wait 1-2 minutes.2. Wipe away the water from both the upper and lower sample surfaces with a dry, lint-free lab wipe.
Between Measurements	Use a dry, lint-free lab wipe to remove samples from both the lower and upper sample surfaces.
Additional Cleaning	<p>Use the following procedure to remove sticky solutions (e.g. proteins) that may have dried down on the sample surfaces.</p> <ol style="list-style-type: none">1. Pipette 2 μL of 0.5 M HCl onto the bottom sample surface. Lower the upper arm. Wait 2-3 minutes.2. Wipe away the HCl from both the upper and lower sample surfaces with a dry, lint-free lab wipe.3. Repeat steps 1-2 with 2 μL of dH_2O.

Guidelines

- Use only a dry, soft, lint-free cloth to clean the front screen.
- Do not use a spray bottle to apply water or any other solutions onto any surface of the instrument as the liquid may damage internal components.
- The use of detergents or isopropyl alcohol as cleaning solvents is not recommended as they may temporarily alter the hydrophobic nature of the sample surfaces.
- Hint: Launch the ScreenLocker app prior to cleaning the touch screen to prevent swiping motions from activating other software activities.

Cuvette and Fluorescence Mode Holder Cleaning

The cuvette and FX tube holders may be cleaned of excess dust using canned air or a damp (not wet) lint free cotton swab.

- Do not allow any liquid to drip into the holders as it may damage the internal components of the instrument.
- Refer to the cuvette manufacturer for guidance on cleaning cuvettes.

Solvent Compatibility

The DS-11 spectrophotometer microvolume sample surfaces are compatible with most solvents typically used in life science laboratories.

Exception: Do not use Hydrofluoric Acid (HF) as the fluoride ion will dissolve the quartz fiber optic cable.

25. Diagnostics



Diagnostics



FX Diagnostics

Although the DS-11 Series proprietary SmartPath™ technology enables accurate microvolume pathlength control and eliminates the need for routine recalibration, labs may choose to run the Diagnostics app to verify that the instrument is working within specifications.

DS-11 Self Test

- Ensure that both the upper and lower microvolume measurement surfaces are clean prior to starting the Self Test microvolume mode assessment.
- For DS-11+ models, remove cuvettes from the holder block and ensure the light path is clear of all obstructions prior to starting the Self Test cuvette mode assessment.
- A spectral plot of the xenon flash lamp intensity and a table that compares measured versus specified values for a panel of specifications will be displayed. If any of the parameters fail to meet specifications, clean the measurement surfaces as described in the chapter entitled "Maintenance" and repeat.

Lamp Reset

The Lamp Reset function should only be used when there is concern that a method optimization was done on dirty sample measurement surfaces.

Microvolume Pathlength Verification

The DeNovix LC-NA verification fluid is supplied as single use vials composed of a non-toxic solution of aqueous nicotinic acid. The solution is used to verify that the microvolume pathlengths are within specifications.

Procedure

1. Ensure both sample measurement surfaces are clean. Refer to the general cleaning instructions in the chapter entitled "Maintenance" for more information.
2. Launch the **Diagnostics** app and navigate to the **Verification** tab.
3. Enter the lot specific Target Absorbance stated on the ampule in the appropriate field.
4. Add 1 μL of dH_2O to the pedestal, lower the arm and click **Blank**.
5. Wipe the upper and lower pedestals using a dry, lint-free laboratory wipe.
6. Vigorously shake the nicotinic acid ampule to thoroughly mix the solution. Ensure all of the solution is in the bottom portion of the ampule before opening.

7. Pipette 1 μ L of the solution onto the sample surface, lower the arm and click **Measure**.
8. Wipe the sample off both the top and bottom sample surfaces.
9. Repeat steps 7 and 8 for a total of 5 measurements using fresh aliquots for each measurement.

LC-NA Single Use Ampules

- The LC-NA solution is supplied in single use ampules that should be used immediately upon opening. Significant changes in concentration and possible verification check failures may occur if the ampule is opened for longer than one hour prior to use.
- Store unopened ampules in a dark, room temperature environment.
- Always use a fresh vial for each verification check procedure.
- Do not use parafilm or other methods of sealing an ampule as evaporation may still occur and result in verification test result errors.
- Note: Only the LC-NA standard available from DeNovix and its authorized distributors should be used for the verification check. No other sources of nicotinic acid are tested and validated for use with the DS-11 verification procedure.

Results

A Pass or Fail message will appear in the results box at the bottom of the screen. If the instrument fails, please clean the surfaces and repeat the test with a fresh aliquot of LC-NA.

Verification Check Troubleshooting

Issue	Probable Causes/ Solutions
Low Absorbance Values	Dirty measurement surfaces or improper Blank. Clean the surfaces, measure a new Blank using fresh source of dH₂O and restart the procedure using a new ampule of LC-NA.
	Multiple measurements made using the same aliquot. Use a fresh aliquot for each measurement.
High Absorbance Values	Pipette tips not changed between aliquots. Use a fresh tip to pipette each aliquot onto the sample surface.
	The sample surfaces are not adequately cleaned between measurements. Wipe both the top and bottom surfaces with a dry lab wipe.
	The solution has concentrated due to prolonged exposure. Use a fresh ampule of solution.
High Standard Deviations	Multiple measurements made using a single 1 ul aliquot. Use a fresh aliquot for each measurement.
	Pipette tips not changed between aliquots. Use a fresh tip to pipette each aliquot onto the sample surface.
	The sample surfaces are not adequately cleaned between measurements. Clean both the top and bottom surfaces between measurements.

FX- Diagnostics

The FX diagnostics feature can be used for instruments with fluorometer mode or for an FX Module USB accessory attached to a DS-11 unit.

Procedure

1. Ensure FX sample measurement tube holder is empty and the lid is closed
2. Launch the **FX Diagnostics** app and push the **Start** button.
 - Follow on-screen instructions regarding tube insertion and orientation.
 - The software tests that each LED is firing and each detector is functioning properly. Results will be reported as Pass/Fail.

26. Troubleshooting

Quick Help

Most issues concerning *accuracy*, *reproducibility*, *negative spectra* and *low nucleic acid purity ratios* are sample or technique related and are resolved by following the suggestions below:

- Establish a new Blank using the appropriate buffer.
- Ensure that the sample isolation procedure is optimized and that samples are purified when required prior to making absorbance measurements.
- Ensure all solutions are homogenous and well-mixed prior to sampling.
- Ensure sample concentrations fall within the absorbance limits of the instrument. In the case of fluorescence assays, ensure sample concentrations fall within the reagent limits as described by the assay manufacturer.

Microvolume Mode

- Ensure both top and bottom microvolume measurement surfaces are clean prior to making the Blank measurement.
- Always remove sample solutions from both the top and bottom measurement surfaces using dry, lint-free wipe immediately after each measurement is complete.
- Use calibrated pipettors and properly fitting tips to ensure a full 1 μL aliquot is delivered to the sample measurement surface. Protein samples sometimes wick up on the outside of the tip and may not be properly dispensed.
- Use a clean pipette tip and a new aliquot of sample for each microvolume measurement.

Cuvette Mode

- Use cuvettes with Z heights of 8.5 mm.
- Use quartz or UV transparent cuvettes for UV range measurements.
- Ensure cuvettes are clean prior to use.
- Fill cuvettes to manufacturer's specifications.
- Confirm the mode selection has been changed on the Run screen to the proper cuvette pathlength prior to a measurement.
- Ensure cuvettes are properly inserted following the etched arrow light path.
- Refer to a reagent kit manufacturer for troubleshooting colorimetric assays.

Fluorescence Mode

- Use 200 μL volumes in a clear thin-walled PCR tube
- Avoid introducing air bubbles into the sample solution when mixing samples.

- Ensure all sample concentrations in the thin-walled assay tubes fall within the limits of the assay or reagent kit for accurate results.
- Follow assay reagent manufacturers' recommendations regarding temperature, incubation time, and protection from ambient light.
- Follow assay reagent manufacturers' recommendations regarding suggested standard curve concentrations and data analysis.
- Confirm that the correct LED excitation source was used.
- Confirm that standard concentrations and dilutions were prepared correctly.
- Confirm that the correct concentration units for the standard curve and the unknown samples were used to calculate the stock concentrations.
- Ensure that the correct optional dilution factor (or μL added in the case of Qubit™ and DeNovix assays) is entered into the appropriate Run screen field *before* a measurement is made.
- Ensure all samples and standards are treated identically in terms of incubation times and temperature.
- Minimize assay tube and solution temperature fluctuations as these may impact the accuracy of the measurement.
- Do not label the side of an assay tube as this could interfere with the sample measurement.

Additional troubleshooting resources (technical notes and FAQ's) are available at our website.

Software Errors

Pop-up messages will provide guidance for software-based errors or invalid user actions. In most cases, simply relaunching the app or restarting the instrument will allow the user to continue to make measurements. Update the software using the **Updater** app if experiencing a reoccurring software error.

Printer and Barcode Scanner

The DS-11 Series is compatible with select label printers* and Opticon OPI 3601 USB barcode scanners. For accessory product troubleshooting and warranty information, please contact the manufacturer of the product. DeNovix support is limited to the specific use of the product with a DS-11 Series instrument.

*Please refer to our website for a list of supported label printers.

27. Customer Support

DeNovix Inc.
3411 Silverside Road, Hanby Building
Wilmington, DE USA 19810
302-442-6911
info@denovix.com

Please include the serial number of your instrument when contacting Customer Support by email. If sending Customer Support a Screen Capture or a report .csv file using the DS-11 email feature, include your name, institute/company, phone number and return email address. **Please note responses will not be sent directly to the email account used by the instrument.**

From the Diagnostics App use the overflow menu to access the TechSupport file package. Include those files, when possible, with a request for support.

Outside of the US, please contact your local distributor for assistance.

Warranty

All product(s) and accessories sold by DeNovix Inc. are under warranty against manufacturing defects in parts.

Disclaimer

All information in this document is for reference purposes only. DeNovix Inc. makes no claims that this document is complete or error-free and assumes no responsibility and will not be liable for any errors, omissions, damage or loss that might result from any use of this document. The information in this document is updated frequently and may be updated at any time. Visit denovix.com to obtain the latest version.

Instructions for Disposal of Packaging and Waste Equipment

DeNovix encourages customers to locally recycle shipping and packaging materials. Corrugated cardboard and paper can be recycled wherever it is accepted locally (e.g., curbside bins, recycling facilities, etc.). For foam and plastics, please contact your local recycling office for information on how to recycle.

When an instrument has reached its end of life, DeNovix recommends that customers responsibly dispose of the equipment by following in line with local regulations. Material construction is available upon request. Visit denovix.com/sustainability for more information.

Research Use Only

DeNovix Inc. products are for research use only.

Qubit, Quant-iT, PicoGreen and OliGreen are trademarks of Thermo Fisher Scientific and its subsidiaries. QuantiFluor is a trademark of Promega Corporation.