



QFX Fluorometer

User Guide

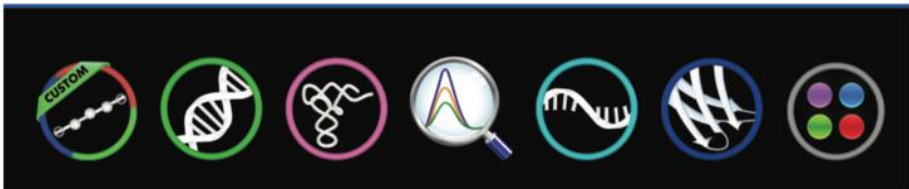

Table of Contents

1. Introduction	4
Product Technology	4
Upgrade Options	4
2. Set up and Safety	5
Cautions	5
Instrument Rear Panel	5
VCCI (Class B) compliance statement for users in Japan	6
3. Instrument Diagram	7
4. Software Quick Guides	8
EasyApps™ Software Icons	8
Software Buttons	9
Software Navigation	9
Top Bar Overflow Functions	10
5. Tech Team Tips	11
Connectivity and Results Data	11
Software Updates	11
Technical Support	11
6. Fluorescence: Basic Operation	12
Fluorescence Measurements	12
Best Practices	12
7. Fluorescence: Standard Curve Method Apps	14
Quick Protocol	14
Run Screen- Assay and Curve Selections	16
Run Screen- Standard Curve View	17
8. Basic Fluorometer App	20
Quick Protocol	20
Excitation Selection and Emission Results	20
9. Data Export and Print Options	22
Export Options	22
Export Via Email	22
Export to a Network Folder	23
USB	23
Print Options	23
10. Utility Apps and Functions	24
User Accounts App	24
Data App	26
Exporting and Deleting Data	26
Settings App	27
Updater App	30

11. 21 CFR App31	
Compliance Ready Software	31
Activation Wizard Overview	32
Activation Wizard 1/7 - Administrator Account	32
Activation Wizard 2/7 – Enter Activation Code	32
Activation Wizard 3/7 - Roles	32
Activation Wizard 4/7 – Signature Meaning.....	33
Activation Wizard 5/7 – Role-Signature Meaning Linking.....	33
Activation Wizard 6/7 – Password Rules.....	34
Activation Wizard 7/7 – Existing Users.....	34
Measurements and Electronic Signed Records	35
Audit Trail	36
Archiving.....	37
12. 21 CFR Mode - Utility Apps and Functions -----	38
User Accounts App.....	38
Data App.....	40
Settings App	41
Updater App	41
13. Lab Tool Apps-----	42
Calculator App.....	42
Timer App.....	43
ScreenLocker	43
14. Maintenance-----	44
Guidelines.....	44
Fluorescence Mode Holder Cleaning	44
15. Diagnostics-----	45
FX Diagnostics	45
16. Troubleshooting -----	46
Fluorescence Mode	46
Software Errors.....	46
Printer and Barcode Scanner	46
17. Customer Support -----	47
Warranty	47
Disclaimer.....	47
Instructions for Disposal of Packaging and Waste Equipment	47
Research Use Only	47

1. Introduction

Product Technology

DeNovix QFX Fluorometers are compact, stand-alone instruments with a high-resolution touchscreen. EasyApps™ software utilizes application specific icons along with a custom operating system to provide an intuitive, easy-to-use instrument for fluorescence measurements.

Key Features

- Stand-Alone Design, no-PC Required
- Hi-Definition 7-inch Touchscreen Interface
- Simple, Intuitive EasyApps™ Software
- Four LED Excitation Options
- Wi-Fi, Ethernet and USB connectivity

Upgrade Options

- Activate 21 CFR Part 11 Compliance Ready Software.

2. Set up and Safety

1. Remove all packing materials.
2. Plug the unit into a 100-240 VAC, 50-60/Hz receptacle using the grounded power supply (Globtek part number TR9CE3000C95CP-NR6B / RoHS Compliant) included with each unit. Input Rating: 100-240V~, 50-60 Hz, IEC 60320/C14 , Output Rating: 36W, 12V@3A
3. Turn on the power switch located in the back of the instrument. The operating system will boot up in less than a minute.
4. Turn off the power switch to shut down the instrument.

Cautions

DO NOT REMOVE COVER

No operator serviceable components inside. Refer servicing to qualified personnel.

The DS-11 Series is designed for indoor use under the following conditions:

Temperature: 15° to 35° C

Humidity: 35 to 65 %

Elevation: 2000m or less

Pollution: Pollution degree 2



Use only the power supply provided with the instrument. Use of the instrument in any manner not specified by the manufacturer may impair the protection provided by the supplied power cord and power supply.

NE PAS OUVRIR L'APPAREIL.

Aucun composant réparable par un utilisateur est inclus. Confiez l'entretien à du personnel qualifié .

Le DS- 11 est conçu pour une utilisation en intérieur dans les conditions suivantes :

Température : 15° à 35° C

Humidité:35 à 65%

Utilisez uniquement le bloc d'alimentation inclus avec l'instrument. Utiliser l'appareil dans des conditions non spécifiées par le fabricant peut compromettre la protection offerte par le câble d'alimentation et le bloc d'alimentation fournis avec l'appareil.

Instrument Rear Panel

The QFX comes equipped with Wi-Fi, Ethernet and three USB ports. The USB ports are used to facilitate data transfer to a FAT32 formatted USB storage device and connect to the accessory FX Module. In addition, the USB ports support the use of select label printers* and an Opticon OPI 3601 USB barcode reader. USB mouse and keyboard devices may also be used with the QFX Fluorometer.

* Please refer to our website for a list of supported label printers.

VCCI (Class B) compliance statement for users in Japan

This is a Class B product based on the standard of the Voluntary Control Council for Interference (VCCI) from Information Technology Equipment. If this is used near a radio or television receiver in a domestic environment, it may cause radio interference. Install and use the equipment according to the instruction manual.

This equipment has been tested for radio frequency emissions and has been verified to meet CISPR 22.2 Class B.



R 007-AH0184
T D190067007

「当該無線設備の送信は**5.2GHz**帯高出力データ通信システムの基地局又は陸上移動中継局と通信する場合を除き屋内においてのみ可能」

3. Instrument Diagram

QFX Fluorometer Component Details

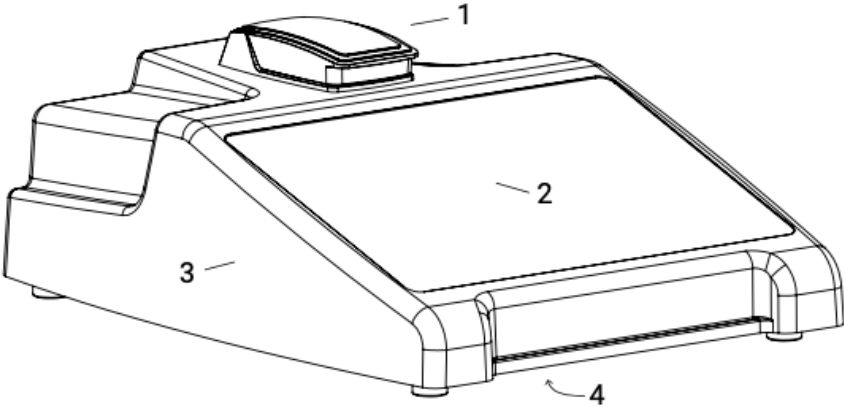



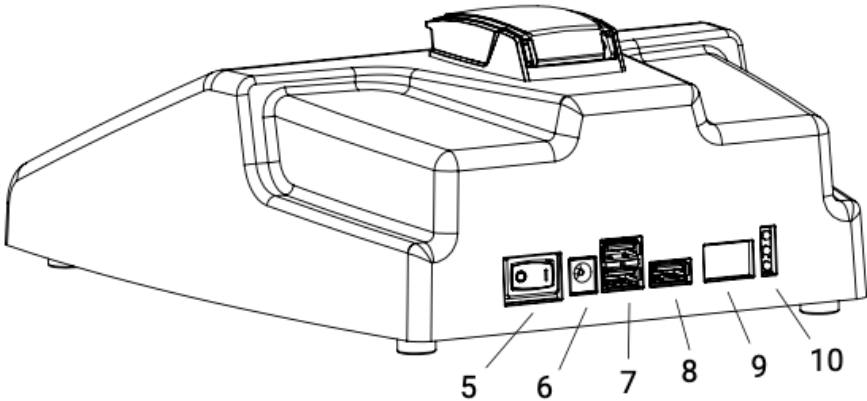









- 1. Fluorometer port
- 2. Touchscreen
- 3. Cover
- 4. Serial number & regulatory info (underside)
- 5. Power switch
- 6. DC power in from power supply
- 7. USB ports (2)
- 8. Ethernet
- 9. Unused
- 10. LED indications



4. Software Quick Guides









EasyApps™ Software Icons



	Home		Add		Select All
	Overflow Menu		Edit		Export
	Clear Selected		Copy		Delete
	Information				

	<p>Progress bars or busy indicators are used to indicate the instrument is in the process of making a measurement. Please wait until the icon has disappeared before performing additional actions.</p>
	<p>The Quick Print icon is only displayed on Report or Graph screens when a label printer is connected to the instrument.</p>
	<p>Auto Export status icons are displayed at the top right of a Run screen. Ensure Wi-Fi is connected prior to making a measurement.</p>

Software Buttons

Software Navigation

	<p>The fluorescence apps Standards Measure button is used to measure standards when building a standard curve.</p> <p>The Samples Measure button is used to quantitate samples.</p>
	<p>The fluorescence apps Replicates On/Off button is used to define if the standards curve enables one or up to three replicates.</p>
	<p>The fluorescence apps Basic Measure button is used to make single measurements not being read from a standard curve.</p>
	<p>Fields with Drop-Down Menus are indicated by black or white triangles located on the center bottom.</p>
	<p>Fields with black underlines are editable by the user. Tapping on the field will enable a keyboard, a numeric keypad or a dialog box.</p>
	<p>Application specific editor options can be accessed using the List Add/Edit button found to the right of some drop-down menus.</p>
	<p>Options buttons are used for such purposes as change units or trend line analysis parameters in the fluorescence apps.</p>
	<p>An accept and return to previous screen button is found in the lower right of some screens. All changes made to a selection are immediate.</p>

	<p>Apps are launched using Home screen icons. Swipe the Home page to the left for additional icons.</p>
	<p>The app Run, Report and Graph screens are accessed either by the tabs on the top bar or by swiping the screens left or right.</p>
	<p>Use the Account Tab drop-down menu on the top action bar in the Run, Report and Graph screens to select a specific account within an app. Use the Accounts app to create and manage accounts.</p>

Top Bar Overflow Functions

Screen Capture	A .png may be exported as described in the chapter entitled "Screen Capture and Export" using this option.
Change Units	Concentration units may be changed in some apps using this option.
Clear Samples	This function saves and then clears all current sample records from the Report and Graph screens.
User Guide	The User Guide may be accessed either from the Overflow icon within any app or by launching the User Guide app.
About	The About feature brings up an information box displaying the current app version number.
Lamp Reset	The Diagnostics app Lamp Reset is used as a means to re-optimize a lamp when necessary.
Tech Support	The Diagnostics app Tech Support feature is used to send instrument related diagnostics files to DeNovix customer support.
Exit	Use the Exit function to close an application.

5. Tech Team Tips

Connectivity and Results Data

- Use the Settings App to configure Wi-Fi or connect an ethernet cable to the rear ethernet port on the instrument.
- Within Settings configure email, network printers and network folders.
- Compatible label printer models enable immediate printing of results.
- Use the share icon  to export results to USB or one of the connected methods above.
- All results are saved on the device until deleted. Export during a measurement session or use the Data App to search for and export results later.
- For ease-of-use, an open access default General account is active when apps are opened. Use the User Accounts app to set up other accounts, password protect them if desired and configure app specific launch defaults as desired.
- Although there is no harm in doing so, there is no need to shut down the instrument each day. The backlight for the screen will automatically turn off to protect the screen and will switch on when touched.

Software Updates

- Connect to the Internet and open the Updater App. Check for updates and download directly to the device. Alternatively, visit our website to download the update package to a FAT32 formatted USB drive. Insert the USB drive and then launch Updater.

Technical Support

Visit our website for instructional videos, Technical Notes and for troubleshooting tips. Contact your DeNovix Distributor or email info@denovix.com for help.

6. Fluorescence: Basic Operation

DeNovix Fluorometer software includes fluorescence EasyApps™ software. The fluorescence app icons will appear on the Home screen.

Activation of **21 CFR Part 11 Compliance Ready Software** affects some aspects of the user interface. Where applicable additional instructions for **21 CFR Mode** operation are provided. Contact DeNovix or your local Distributor to purchase an activation code.

The table below lists the four LEDs included in the QFX. Users must select the appropriate LED for the assay that they choose for quantification.

LEDs	Excitation Filter Range	Emission Filter Range
UV	361 - 389 nm	435 - 485 nm
Blue	442 - 497 nm	514 - 567 nm
Green	490 - 558 nm	565 - 650 nm
Red	613 - 662 nm	664 - 740 nm

Fluorescence Measurements

- Insert a PCR tube pre-filled with the fluorescent solution. Close the cover and tap **Measure**.

Notes:

- *Use clear thin-walled 0.5 mL plastic PCR tubes only*
- *Measure 200 µL volume samples.*



Best Practices

- Ensure all sample concentrations in the thin-walled assay tubes fall within the limits of the assay or reagent kit for accurate results.
- Use 200 µL volumes in a clear thin-walled PCR tube.
- Lower the cover before tapping the measure button.
- Avoid introducing air bubbles into the sample solution when mixing samples.
- Follow assay reagent manufacturers' recommendations regarding temperature, incubation time, and protection from ambient light.
- Follow assay reagent manufacturers' recommendations regarding suggested standard curve concentrations and data analysis.

- Ensure all samples and standards are treated identically in terms of incubation times and temperature.
- Minimize assay tube and solution temperature fluctuations as these may impact the accuracy of the assay. Samples at higher temperatures will generally have lower fluorescence.
- Do not label the side of an assay tube as this could interfere with the sample measurement.

7. Fluorescence: Standard Curve Method Apps

The EasyApps™ listed below are designed using the same basic architecture. Each app includes a choice of four excitation LEDs (UV, Blue, Red, Green) and a variety of assays. The end user is responsible for selecting the proper choice based on the analyte that will be used for quantification.

	Fluoro dsDNA	<ul style="list-style-type: none">•DeNovix dsDNA Broad Range•DeNovix dsDNA High Sensitivity•DeNovix dsDNA Ultra High Sensitivity•Quant-iT™ PicoGreen•Quant-iT™ dsDNA HS•Quant-iT™ dsDNA BR	<ul style="list-style-type: none">•Qubit™ dsDNA BR•Qubit™ dsDNA HS•Quantifluor dsDNA•Quantifluor One dsDNA•Qubit™ 1X dsDNA HS•Qubit™ 1X dsDNA BR
	Fluoro RNA	<ul style="list-style-type: none">•DeNovix RNA Assay•Quant-iT™ RiboGreen•Quant-iT™ RNA HS•Quant-iT™ RNA BR•Qubit™ RNA HS	<ul style="list-style-type: none">•Qubit™ RNA BR•Quantifluor RNA•Quant-iT™ microRNA•Qubit™ microRNA
	Fluoro ssDNA	<ul style="list-style-type: none">•Quant-iT™ OliGreen•Qubit™ ssDNA•Quantifluor ssDNA	
	Fluoro Protein	<ul style="list-style-type: none">•Quant-iT™ Protein•Qubit™ Protein•Qubit™ Protein BR	
	Fluoro Std Assays	<ul style="list-style-type: none">•All entries to be defined by the user	

Quick Protocol

1. Launch the app from the **Home** screen.
2. Select an excitation LED using the drop-down menu on the **Run** screen.
3. Generate a new curve:
 - Insert the standard (200 µL total assay volume in a thin-walled PCR tube) into the sample holder and lower the cover. Measure at least one replicate for a minimum of 2 standard concentrations.

- Alternatively, import a saved curve or list of sample concentrations
4. Tap the **Samples** radio button.
 - Optional: Enter a sample name and a dilution factor to be applied to the reported concentration.
 5. Quantitate a sample using the **Measure** button.

Refer to the manufacturer of the assay reagent for assay specific instructions.

Note:

- *DeNovix and Qubit™ assays will have predefined standard concentrations and specified units.*

Run Screen- Assay and Curve Selections

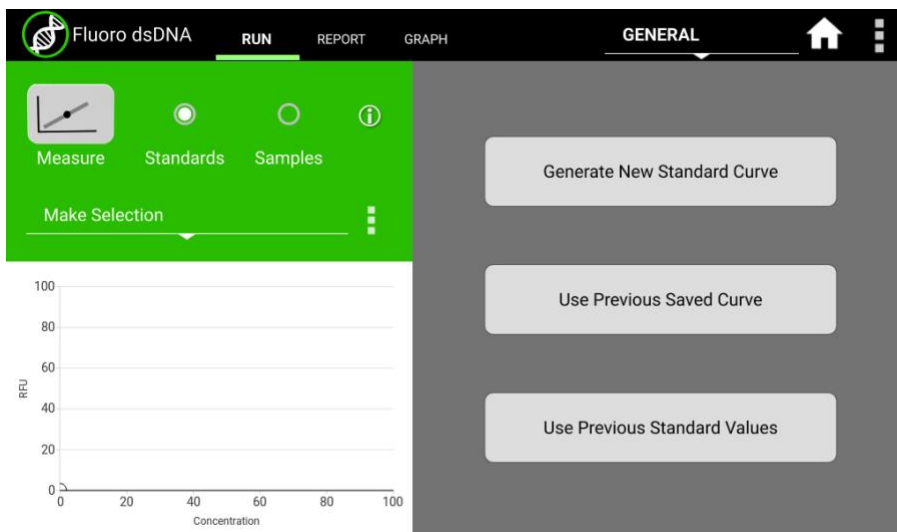

Excitation Source (LED) and Assay Selection

- Select the LED from the drop-down menu in the left panel. The user must choose the appropriate LED for the analyte in use.
- New assays may be entered using the List Add/Edit button.
- User defined assays may be used by all accounts but may be modified or deleted only by the account owner.

Curve Options

Generate New Curve

- Choosing this option will pop-up a dialog window used to enter the concentration values for the standards.
- Verify the concentrations of the standards for the LED / Assay chosen. The standard concentrations for all other assays are determined by the user at the time of the assay
- Trend line analysis options and concentration units used may be changed using the advanced options button.
 - **Blank:** If selected, the first row in the standards table is used to measure a Blank. The average RFU value of the blank measurements will be subtracted from all standard and sample measurements. If the Blank is not selected, the initial concentration for preconfigured assays will be set to 0.00. This standard is typically the reagent/fluorophore solution without any nucleic acid or protein.
 - **Trend Line:** If selected, the trend line will be forced through the lowest standard concentration. When a Blank is used, the trend line will be forced through the graph origin (0,0).

Use Previous Curve or Std Values

- Choosing this option will pop-up a dialog window with a radio button selector for saved standard curves and saved standard curve concentration lists.
- All modifications to a curve or list are effective **immediately**. It is important to save the selection with a new name prior to making any changes if you do not want to modify the original curve or standards list. Changes to a curve do not affect previously measured samples.
- Although all saved lists and saved curves are available for use by all accounts, only the account holder may modify the selection.

Run Screen- Standard Curve View

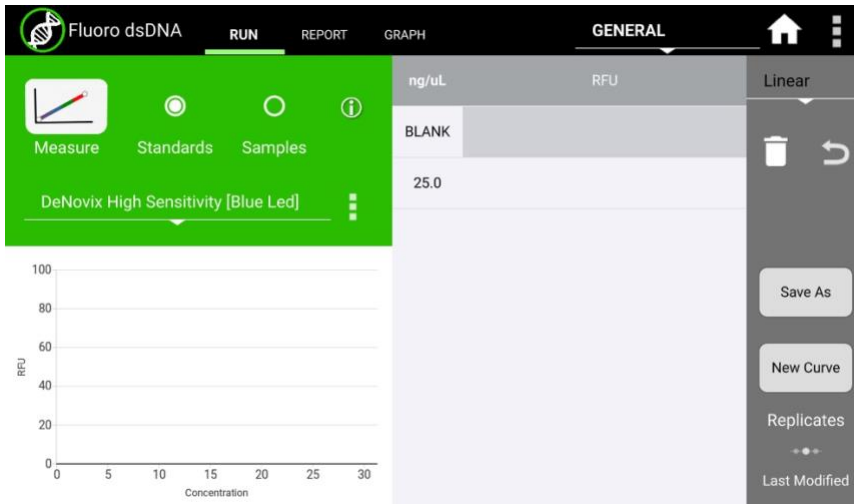

- The **Stds** button will pop-up the Edit Concentrations for Standard Curve window.
- The **Delete and Undo** icons are used to manage the RFU values within the table.
- The **Save** button will pop-up the Save Values window. Either concentration values or concentration values with the associated RFU values may be saved.
- The **New Curve** button is used to generate a new curve or load a previously saved curve. All sample data generated using the Samples radio button will be automatically saved and accessible using the Data app.
- The **Replicates** arrow button enables the use of up to three replicate measurements per standard concentration. The average of the replicates will be used to generate the trend line.

Run Screen- Sample Results View

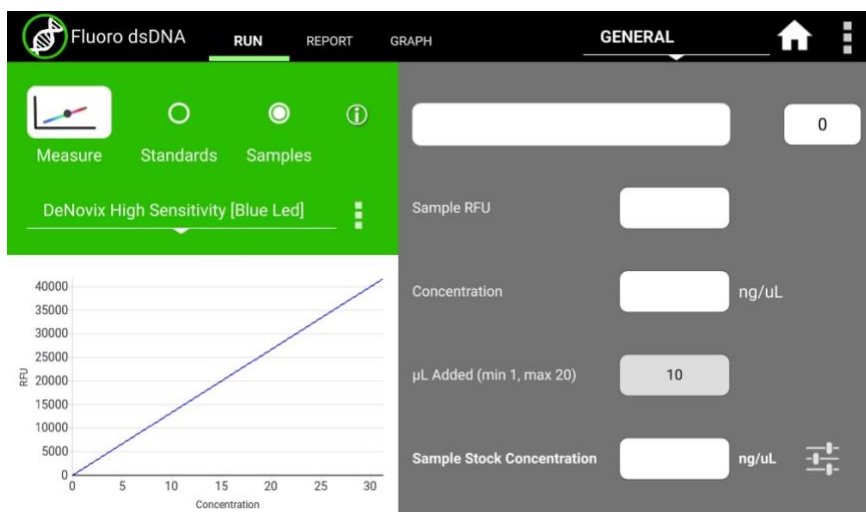

- Use the **Samples** radio button to display the measurement results view.
- The samples **Measure** button will be disabled until one replicate of at least two standards are measured using the standard curve view.
- The **Concentration from Curve** results are calculated directly from the standard curve trend line. Results are reported in terms of the units used to derive the trend line.
- The **Optional Dilution Factor** (or the **µL Added** value for Qubit™ assays) will be applied as a multiplier to the Concentration from Curve value and the result reported in the Sample Stock Concentration field.
- The **Sample Stock Concentration** results are reported in terms of the units selected by the user. The value saved in Report will be displayed in terms of the units in use at the time of the measurement.

New Standard Curve Assays/Methods

Each new method requires a unique name. In addition, the following parameters must be defined:

Excitation Source

- Use **LED Radio** buttons to select the excitation source.
- The **LED Wizard** may be used to determine a compatible excitation source if not known. The software will make a measurement using each of the four excitation sources and will report the associated RFU in the color-coded boxes.
- Some fluorophores do not exhibit significant fluorescence unless bound to a protein or nucleic acid. It may be necessary to set up an assay reaction to best use the LED Wizard.
- The standard curve assay methods use one excitation source to determine the concentration of a sample based upon the RFU measured using the corresponding emission filter set.

Advanced Options

- Use the **Advanced Option** buttons to set both the Trend Line/Blank selections as well as the standard curve units.

Although all accounts may use any saved method, only the method account holder or an administrator may modify or delete the new method.

8. Basic Fluorometer App



Basic Fluorometer

This app enables DeNovix systems to be used as a versatile fluorometer for applications such as dye QC checks and assay development. The app is especially useful for fluorophores with significant Stoke shifts as it allows the user to excite a sample with one LED and obtain RFU results from multiple emission channels.

Quick Protocol

1. Launch the app from the **Home** screen.
2. Select an excitation LED using the radio buttons.
3. Optional: Create and Save a used defined method (LED selection and user defined assay name).
4. Optional: Enter a sample name.
5. Tap the **Measure** button.

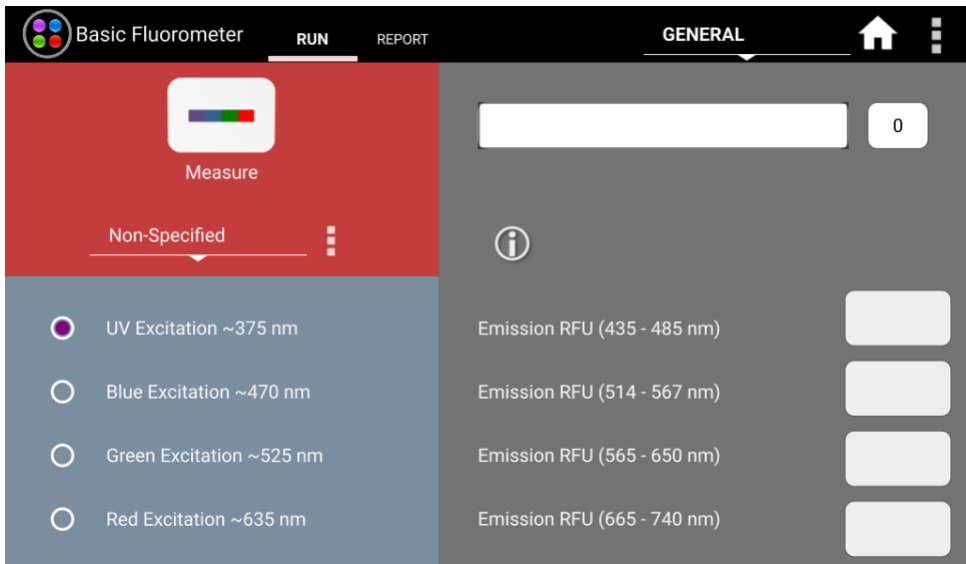

Excitation Selection and Emission Results

- Select an excitation source (LED) or LED plus fluorophore combination.
- The selected LED is the **only** excitation source used during a measurement. However, the emission RFU will be collected for each longer wavelength emission filter set.
 - For example, if the blue LED is selected, the emission results for the blue, green and red channels will be reported. If the green LED is selected, only the green and red channel results will be reported.

- User defined fluorophores may be entered using the List Add/Edit button.
 - The Add button will pop-up a window that includes a LED Wizard. Tapping the Wizard button will result in the sample being excited by each LED and the RFU measured by the corresponding detector. The user can select the LED most compatible with the method.

9. Data Export and Print Options

Export Options

From the Report screen, sample data may be exported via email, to network printers, network folders or saved to a FAT32 formatted USB flash drive. Export options vary depending on the destination. For instance, the full contents of a csv file cannot be sent to a network printer.

Export Formats

CSV file

- The default .csv file format for each absorbance measurement app includes all absorbance vs wavelength data for the app specific measurement wavelength range as well as the calculated data displayed on the app Report screen. The csv file can be saved to USB, saved to a network folder or emailed.
- To open an exported .csv file on a computer, the DeNovix instrument and the computer must **both** be set to use either period or comma number formats. The instrument's number format is determined by the language selected in the Settings app.

PDF Report

- A pdf report file can be generated for each measurement app. The pdf can be saved to USB, emailed, printed to a network printer or saved to a network folder.

Screenshots

- Use the overflow menu to capture the active screen. This is a convenient way to export graphs from the Graphs page. The png file may be exported by email, saved to a network folder, saved to a USB drive or printed to a network printer.

Export Via Email

- Screen captures, .csv files and pdf summary reports may be exported via email.
- Use the User Accounts app **Address Book** to save frequently used email addresses.
- It is recommended that a new, dedicated POP3 Gmail or Outlook account be used for all outgoing email from the QFX. This type of account works very well with the instrument's operating system and prevents personal incoming email from being stored on the unit.

Export to a Network Folder

The instrument can export to SMB network folders connected to the same network as the instrument. For best results connect to the network through an ethernet connection, especially if exporting pdfs and images. See Settings App section for more information.

USB

- Screen captures, pdf reports and data .csv files may be saved to a FAT32 formatted USB flash drive.
- There are two USB ports on the back of the instrument and one on the side although only one storage device is recognized at a time. The two additional ports may be used for the FX Module accessory, label printers, keyboards, mouse and barcode readers.
- DO NOT USE INSTRUMENT USB PORTS TO CHARGE OTHER DEVICES.
- DO NOT CONNECT MOBILE PHONES TO USB PORTS.

Print Options

- The QFX can print to networked printers or to select label printers. Label print-outs are in black and white. See our website for a list of supported label printers and supported label sizes.

Network Printers

- Screenshots and pdf summary reports may be printed to network printers.
- Use the Settings app to search for and add printers. Printers that are configured as driverless CUPS printing are supported.
- Please contact DeNovix or your local distributor for a list of recommended printers if your current printer is not recognized on the network.

10. Utility Apps and Functions



User
Accounts



Data



Settings



Updater

Standard Mode Instructions

This section describes functionality for instruments that are not running in 21 CFR Mode. Please see the 21 CFR Utility Apps and Functions section for details about how the apps are configured in that mode.

User Accounts App

The User Accounts app allows users to create and manage individual accounts. Users can adjust their default settings. Accounts are also used as a means of segregating data when performing searches in the Data app.

App Structure

Accounts are listed in the left pane of the screen. A menu of app function options is presented in the action bar, where the selected option is highlighted with a blue background.

Select a user account from the dropdown list in the top grey bar and select an option to edit: Profile, Report Emails, File Share, and Defaults.

App Functions

The basic functions controlled using the Account app are as follows:

- Adding and deleting accounts
- Managing passwords for accounts
- Managing email addresses associated with an account
- Setting account specific app protocol preferences

Default System Accounts

There are two preconfigured system accounts built into the software - the General Account and the Primary Administrator Account. These accounts may not be deleted.

Primary Administrator

- This account is used to manage instrument settings. It is not used within the measurement applications.
- The primary administrator account is not initially password protected. A password may be applied at any time.

General Account

- This account is used as the default selection for all apps each time an app is opened. This account may not be password protected or deleted.

User Account Types

There are two types of accounts that may be added, edited or deleted.

User Added Standard Accounts

Any user may add a standard level account. It is not necessary to select an account before adding a new standard account.

Standard accounts may only modify or delete protocols or emails created from within their account.

User Added Administrator Accounts

- An administrator level account may only be created by another administrator. The primary administrator or another existing administrator account must be highlighted in order to enable the adding of a new administrator.
- Administrator accounts may modify or delete user entries of any sort created from within any account. A drop-down menu is used to select the desired account.
- Administrators may change the password for any account as well as delete any account.

Account Passwords

- Passwords are optional for all added administrator or standard user accounts.
- Contact the holder of an administrator account if a standard user account password is forgotten.
- Contact DeNovix customer support or your local distributor if the Primary Administrator password is forgotten. Please have the serial number of the instrument available when requesting help for the Primary Administrator password reset.

Deleting an Account

- When an account is deleted, all protocols and custom report formats created by that account are reassigned to the General Account.
- The account specific saved data will also be permanently removed from the instrument at the time the account is deleted.

Tab - Email Addresses

Multiple "to" email addresses for exporting results may be set up for each account. The nickname is used in the drop-down list presented on an export destination dialog box.

Tab - Defaults

Some application specific default settings may be defined on a per account basis. Launch the Accounts app from the Home screen and then use the drop-down menus to select the account, the app and the setting of interest.

Note: The default selections for the General Account may not be modified.

Data App

This app allows the user to search for past data by user account, date or application. Data can then be added to the Report and Graph screens for review and export. Previous results can be deleted from within the Data app.

Search Options

- Data is automatically filtered based upon the Account selected using the tab on the top action bar.
- Once the filter criteria have been selected, tap the **Search** button at the bottom of the screen. Tap any column header to sort the results list.
- Highlight the sample(s) of interest and tap the **Add to Report** button to include the samples on the Report screen.
- Data from the same app type for the samples to be added to the Report or Graph screens. Clear the previous selects to find data from a different application.

Exporting and Deleting Data

- All data is automatically saved to the QFX on-board database at the time of measurement.
- The **Export Selected Samples** function available from the Report screen are the same options available in the Report screens discussed in the previous Data Export and Print options section.
 - When the export function is used, the data is **not** deleted from the database and can be accessed using the Data app.
- The **Delete** function available from the Report and Graph screens.
- When the **Delete** function is used, the data is *permanently* deleted from the instrument database and cannot be restored to the instrument.
- The storage capability of the QFX is sufficient for several years of data for a lab with average use.

Settings App

This app allows access to system information and settings. General accounts may see basic system information. Administrator accounts can access the Permissions tab to adjust access to system settings. The Settings app provides access to the following functions and information:

System Info

View software and firmware versions, IP addresses, current language and hostname.

Date/Time

Select manual or automatic date and time options.

Language













Select the language of operation for the device. Not all languages are fully translated. Setting the language also determines whether a period or a comma is used for the decimal place.

Network Information

The Wi-Fi and Ethernet MAC addresses and IP addresses can be found under this setting.

Permissions

Administrator level accounts can use Permissions to set access to the Settings app tabs for general level accounts.

- | | |
|---|---|
| <input checked="" type="checkbox"/>  System Info | <input checked="" type="checkbox"/>  Date/Time |
| <input checked="" type="checkbox"/>  Language | <input checked="" type="checkbox"/>  Network Information |
| <input type="checkbox"/>  Permissions | <input checked="" type="checkbox"/>  Sound |
| <input checked="" type="checkbox"/>  Storage | <input checked="" type="checkbox"/>  WiFi |
| <input checked="" type="checkbox"/>  Ethernet | <input checked="" type="checkbox"/>  Display |
| <input checked="" type="checkbox"/>  Network Folders | <input checked="" type="checkbox"/>  Network Printing |
| <input checked="" type="checkbox"/>  Email | |

21 CFR Mode: Administrators can disable the “Discard” button from this screen if desired.

Sound

Play a test sound.

Storage

Displays current storage statistics.

Wi-Fi

Turn Wi-Fi on or off and connect/disconnect from a network.

Connect the instrument to a 2.4 GHz or 5 GHz network.

Select the country where the unit is installed in order to ensure the Wi-Fi radio uses the correct frequency bands.

DeNovix instruments are compatible with eduroam using login credentials provided by your institution. See Technical Note 225 on denovix.com for a step-by-step guide to connect.

Ethernet

Ensure that the Ethernet cable is connected.

Tap the Edit button to configure Ethernet connection.

Contact your local IT department if additional help setting up Wi-Fi or Ethernet is needed.

Display

Includes controls for screen brightness and when the screen sleeps.

Network Folder

The instrument can export to SMB network folders connected to the same network as the instrument. For best results connect to the network through an ethernet connection, especially if exporting pdfs and images.

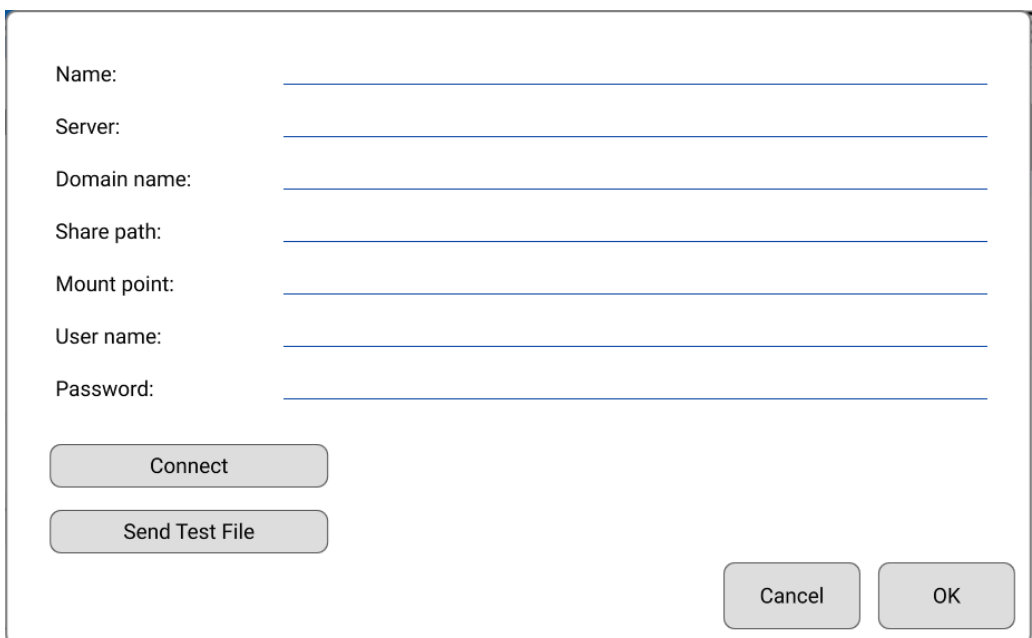

The screenshot shows a configuration dialog box for a network folder. It contains the following fields and buttons:

- Name: _____
- Server: _____
- Domain name: _____
- Share path: _____
- Mount point: _____
- User name: _____
- Password: _____
- Connect button
- Send Test File button
- Cancel button
- OK button

Enter the following information. See DeNovix Tech Note 122 or your IT Department for additional help.

- **Name** - Create a name for your network connection.
- **Server** - The IP address of computer or server where the shared folder is located. The IP can be found in Windows Network Status under “Properties” or by entering **ipconfig** at the Windows command prompt.
- **Domain name** - The domain name when the shared folder resides. From a windows command prompt enter **echo %userdomain%**. Do not include slashes or backslashes.
- **Share path** - The share name of the shared folder. In Windows, find this by right clicking on the shared folder and viewing the properties. The share name should be a single word. No slashes or backslashes.

The example below shows a correctly shared folder.

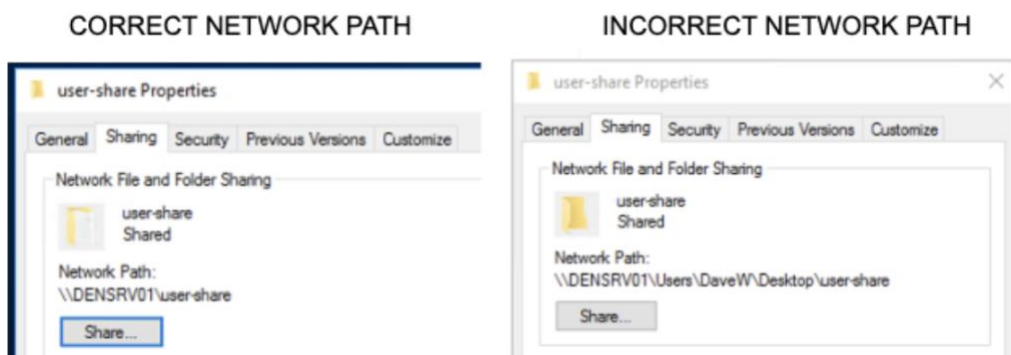

- **Mount point (optional)** -The path to a subfolder within the main shared folder. Example input **sub1/sub2** is sub1 is a folder inside the main shared folder and sub2 is within folder sub1.
- **User name** - The username accessing the share. No slashes or backslashes.
- **Password** - Password of the User name account.

Press **Connect** to connect to the network folder. Press **Send Test File** to transfer a time stamped text file **denovix.txt** to the network folder.

Network Printing

Search and add compatible network printers for easy export of hard copy reports.

Email

Email Set-Up

- Ensure that the instrument is connected to Wi-Fi or Ethernet.
- Launch the Settings app and navigate to the Email section on the left scroll menu.
- Enable the **POP3** option on your Email configuration. Do not use an IMAP account as messages from IMAP accounts could occupy a significant amount of the instrument's memory.

See Technical Note 205 on denovix.com for a step by step walkthrough of email setup. Refer to your IT support group and DS-11 Series Technical Notes on denovix.com if additional assistance is required.

Updater App

Updater is used to update system software and firmware to the most current available versions. Updates may be downloaded using the Updater app when connected to Ethernet or Wi-Fi. An Ethernet connection is recommended for software updates.

Updates may also be downloaded to a FAT32 formatted USB drive from our website. Download the update file to the root directly of the USB drive. Do not change the file name. Insert the USB drive in the device and then launch the Updater app. Follow the onscreen instructions to update.

Note: The update process may require one or more automatic system reboots.

11. 21 CFR App

Compliance Ready Software

DeNovix 21 CFR Part 11 Compliance Ready Software is available for activation on DS-11 Series, QFX and DS-C instruments. An activation code is required and can be purchased from DeNovix or a DeNovix distributor. Once activated, 21 CFR Mode provides a suite of seamless, integrated controls for electronically signing records, managing user accounts, configuring the organization and accessing the audit trail. The software enables the following:

- A convenient configuration wizard for easy set up and customization during activation.
- User login with unique User ID and password for each user.
- Operation as a closed system with a single, continuous period of controlled system access.
- Users review results and electronically sign records while logged in. Records can be electronically signed with a Signature Meaning that is associated with the user's assigned Role.
- Prompt export (and back up) of electronically signed records to a second location when completing a measurement session.
- Export of human readable pdf reports and optional raw data such as csv files. The pdf report includes details of each electronic signature associated with a record.
- A user interface for viewing stored information but no ability to directly access and alter electronically stored data.
- Administrator tools to customize and manage the organization's Roles, Signature Levels and Signature Meanings.
- Administrator tools for User Account management including Role assignment, activation, deactivation, name changes and password resets.
- An Audit Trail function to automatically log system events and user activities in a database. If audited, System Administrators can easily search the Audit Trail and export a human readable .csv report.

Activation Wizard Overview

The activation wizard is a step-by-step procedure for setting up an instrument to comply with your organization's needs. Default valves are included but are fully configurable during activation. 21 CFR Mode:

- Each user is assigned to Role
- Each Role has a Signature Level which establishes a rank in the organization
- A set of Signature Meanings must be defined (tested, rejected, approved, etc.)
- Roles are linked to one or more Signature Meanings, meaning that any User who is assigned to a Role can electronically sign a record with one of the available signature meanings.
- Once the organization rules are configured, each user is assigned to a Role. This establishes the signature privileges of each user.

Activation Wizard 1/7 - Administrator Account

To begin, open the 21 CFR app and select an Administrator level account from the Account selector at the top of the screen. If a user created Administrator account isn't selected or none exists, the user is prompted to create a new Administrator account.

When 21 CFR Mode is activated, the open access accounts "General" and "Primary Admin" are deactivated.

Activation Wizard 2/7 – Enter Activation Code

Enter the twenty-digit activation code and press Apply Code.

Activation Code 2/7

21 CFR Part 11 compliance ready software can be activated on this instrument. Please enter your activation code. To purchase an activation license, US customers should contact DeNovix and international customers should contact their local DeNovix Distributor. Please include the serial number in your request.

Enter Code: _____ - _____ - _____ - _____ - _____

Activation Wizard 3/7 - Roles

Users will be assigned to a Role in the final step of activation. In this step set up the Roles for the organization. Each Role includes a value for Signature level. The Signature Level value establishes a hierarchy in the organization. Users can view data for users at their Signature Level and below. But they cannot view data for Roles with higher Signature Level number.

Define the Roles for the organization. These may be changed later by a System Administrator

Role	Signature Level
System Administrator	1000
Principle Investigator	900
Lab Manager	700
Sr. Scientist	500
Scientist	400
Sr. Technician	300



Next

Activation Wizard 4/7 – Signature Meaning

Each User, through their assigned Role, will be able to electronically sign records with the Signature Meanings as defined in this table. Configure the Signature Meanings as required for the organization but using the add, edit and delete icons. At least one Signature Meaning must exist.

Configure Organization (Signature Meaning) 4/7

Define the signature Meanings for the organization. Permitted Signature Meanings will be assigned to Roles in the next step of configuration. These may be changed later by a System Administrator.

Signature Meaning
Tested
Reviewed
Approved
Released
Rejected

Previous Next

Activation Wizard 5/7 – Role-Signature Meaning Linking

In this step, set the Signature Meanings for each Role. Select a Role from the table and then check Include to allow that Role to electronically sign records with that particular Signature Meaning. In the example shown, the Sr. Technician Role can e-Sign records with Tested, Reviewed and Edit sample name/description Signature Meanings. Any Role must be linked to at least one Signature Meaning.

Configure Organization (Role - Signature Meaning) 5/7

Select a Role and then check boxes to assign the Signature Meanings permitted for each Role. These may be changed later by a System Administrator.

Role	Signature Meaning	Include?
System Administrator	Tested	<input checked="" type="checkbox"/>
Principle Investigator	Reviewed	<input checked="" type="checkbox"/>
Lab Manager	Approved	<input type="checkbox"/>
Sr. Scientist	Released	<input type="checkbox"/>
Scientist	Rejected	<input type="checkbox"/>
Sr. Technician	Edit sample name/description	<input checked="" type="checkbox"/>

Activation Wizard 6/7 – Password Rules

Set password rules as desired for the organization. Some requirements are optional. Minimum password length and account locking after failed attempts to login are requirements of 21 CFR Part 11 compliant software.

Configure Password Rules 6/7

Set the password rules for the organization

Rule	Required	Quantity
Minimum password length	<input checked="" type="checkbox"/>	6
Require special character	<input type="checkbox"/>	0
Require capital letter	<input checked="" type="checkbox"/>	1
Require numeric character	<input checked="" type="checkbox"/>	1
passwords automatically expire (days)	<input checked="" type="checkbox"/>	90
maximum number of login failures before account is locked	<input checked="" type="checkbox"/>	5

Activation Wizard 7/7 – Existing Users



The final step of the Activation Wizard is to complete the user records for any existing user accounts that are on the system. Each user must have a User ID, First Name, Last Name, Role and a temporary password set in order to complete the wizard. Edit user accounts by selecting them from the list and then using the edit icon.

Note: This is last opportunity to delete existing user accounts. After 21 CFR activation is completed, user accounts may be deactivated, but they may not be deleted.

Existing Users 7/7

Select a Role and then check boxes to assign the Signature Meanings permitted for each Role. These may be changed later by a System Administrator.

User ID	First Name	Last Name	Role	Password	Complete?
CFRAdmin	James	Smith	System Administrator	Done	<input checked="" type="checkbox"/>
Ashelby	Arthur	Shelby	Lab Manager	Done	<input checked="" type="checkbox"/>
APowers	Austin	Powers	System Administrator	Done	<input checked="" type="checkbox"/>

Measurements and Electronic Signed Records

DeNovix 21 CFR compliance ready software enables users to electronically sign results according to their signature level and permissions established by a system administrator. Organizations are responsible for establishing standard operating procedures to ensure users and the organization comply with all facets of the 21 CFR regulations.

Blanks and Sample Measurements must be electronically signed.

Follow app specific instructions for creating methods or generating standard curves if applicable.

After each measurement, the user must choose to Sign or Discard a result.

- **Discard:** The result is not saved. SOPs should be established related to the use of discard to avoid 'testing into compliance' scenarios. The Discard button may be disabled by an Administrator account using the Permissions tab in the Settings app.
- **Sign:** With the first measurement of each session, the user must verify the user ID and enter a correct password. Subsequent measurements are signed with the user ID only.

Measure additional samples until ready to end the session.

DeNovix recommends that the users immediately export signed records and reports when ending a session. As a reminder, at the end of each measurement session the user will be asked if they would like to generate a 21 CFR Report for the session.

The 21 CFR Report is a non-editable, human-readable pdf report summarizing data from all measurements within a session (or selected results within a session or the Data app).

The report includes result information, electronic signature details for each result and the MD5 (hash) value of a csv file of all data included in the report.

21 CFR Reports and csv should be backed up to a secondary location (USB drive, network folder, hard copy to printer, etc.). The system administrator is responsible for ensuring systems are properly backed up.

Standard curve replicates do not need to be signed. The values of all replicates used to generate a standard curve are saved with each result. The user signs the measurement which binds the sample result to the curve used to generate it.

Audit Trail

DeNovix 21 CFR software continually creates an Audit Trail which is a time-stamped log of events and changes that take place in the system throughout the life of the instrument. Administrators can search the audit trail to filter the results by date, Event Type, User ID and Signature Meaning.

The screenshot shows the 'Audit Trail Search' interface. It features a search bar at the top with a 'SEARCH' button. Below the search bar are several filter options: 'Start Date' and 'End Date' with calendar icons, 'Event Type - All', 'User ID - All', and 'Signature Type - All', each with a dropdown arrow and a search icon. A 'Search' button is located at the bottom left. The main area displays a table of results with columns: Account, Event, Signature, and Date. The table contains several rows of data, including events like 'Signature Released', 'Record Management', and 'Signature Approved'.

Account	Event	Signature	Date
CFRAdmin	Signature	Released	2020 Aug 4 16:12
CFRAdmin	Record Management		2020 Aug 4 16:11
CFRAdmin	Signature	Approved	2020 Aug 4 16:11
CFRAdmin	Record Management		2020 Aug 4 16:11
CFRAdmin	Signature	Approved	2020 Aug 4 16:10
CFRAdmin	Signature	Approved	2020 Aug 4 16:10
CFRAdmin	Record Management		2020 Aug 4 16:05
CFRAdmin	Record Management		2020 Aug 4 16:03

Event types tracked include Signature, System, User Account, Record Management and Application/Machine errors. Some examples of logged events are the electronic signature of a result, deactivating a user, a failed login attempt, exporting a result and archiving a record. This list is only representative and is not a complete list of all actions logged.

Set the filters as desired and press Search to update the result list. Select records and press "Add to Report". Move to the Report Tab to see additional information about each audit trail entry. To export a copy of the Audit Trail as a .csv file, select records, press the export icon and select the destination.

The screenshot shows the 'Audit Trail List' interface. It features a 'REPORT' tab and a 'CFRADMIN' user name. Below the tab are 'Clear' and 'Share' buttons. The main area displays a table of results with columns: Account, Result ID, Event, Signature, Comment, and Date. The table contains several rows of data, including events like 'System', 'Record Management', and 'Signature Approved'.

Account	Result ID	Event	Signature	Comment	Date
CFRAdmin		System		Update user information CFRAdmin, John, Smith, System Administrator Exported	2020 Aug 4 15:43
CFRAdmin	0426620200804160249	Record Management		Exported	2020 Aug 4 16:03
CFRAdmin	0426620200804160452	Record Management		Exported	2020 Aug 4 16:05
CFRAdmin	0426620200804160452	Signature	Approved		2020 Aug 4 16:10
CFRAdmin	0426620200804160452	Signature	Approved		2020 Aug 4 16:10
CFRAdmin	0426620200804160452	Record Management		Exported	2020 Aug 4 16:11
CFRAdmin	0426620200804160452	Signature	Approved		2020 Aug 4 16:11
CFRAdmin	0426620200804160452	Record Management		Exported	2020 Aug 4 16:11

IMPORTANT NOTE FOR SYSTEM ADMINISTRATORS!

The Audit Trail should be backed up on a regular basis by a System Administrator. DeNovix recommends that organizations establish procedures to regularly export the full Audit Trail log via .csv to a backup file location.

Archiving

Results that have been previously exported from the instrument may be permanently deleted through use of the Archiving function in the 21 CFR app. This is the only mechanism for removing data from the instrument. Prior to removal, the Administrator should confirm records that will be removed have been properly backed up to another location. Use the Data app to export additional copies of the electronically signed results prior to archiving. **Archiving immediately and permanently deletes all data associated with the signed record. Do not archive a record before confirming a secure copy of the record exists in a secondary location or has been properly managed according to the organization's records retention policies.** All Archiving events are captured in the Audit Trail database.

Filter the results by date, App, User ID and Signature Type as desired. Touch Search to update the search results. Select desired results and then Add to Report.

Signature/UserID	Sample	Date
Tested B		2021-4-14 14:19
Tested B		2021-4-14 14:18
Tested B		2021-4-14 14:18
Tested B		2021-4-14 14:13
Tested B		2021-4-14 14:12
Tested B	BLANK	2021-4-14 14:11
Rejected B		2021-4-14 13:55

The Report tab view shows if a result has been previously exported from the system. Only results that have been exported can be selected for archiving. Touch the delete icon to initiate archiving. The system Administrator must enter their password to complete archiving. **The archived records are immediately deleted. Since the record has been previously exported, an additional backup copy is not created at the time of archiving.**

Exported	Date&Time	Signature/UserID	App	Sample ID	Sample Name
<input checked="" type="checkbox"/>	2021-4-14 15:51	Approved B	dsDNA	6942020210414155102	BLANK
<input checked="" type="checkbox"/>	2021-4-14 15:51	Tested B	dsDNA	6942020210414155134	
<input checked="" type="checkbox"/>	2021-4-14 15:51	Tested B	dsDNA	6942020210414155152	
<input checked="" type="checkbox"/>	2021-4-14 15:52	Released B	dsDNA	6942020210414155219	
<input checked="" type="checkbox"/>	2021-4-14 15:52	Tested B	dsDNA	6942020210414155241	

12. 21 CFR Mode - Utility Apps and Functions

21 CFR Mode Instructions



This section describes functionality for instruments that are running in 21 CFR Mode. Please see the Utility Apps and Functions section for details about how the apps are configured in Standard mode.

User Accounts App

System Administrators use the User Accounts app to create and manage user accounts on the device. The app is also used for selecting roles, deactivating users, setting temporary passwords and changing account information. Each user is required to have a unique User ID and password that meets the organization’s password rules set in the 21 CFR App. All User Account changes are captured in the 21 CFR Audit Trail data.

IMPORTANT: Organizations are responsible for following the strict security requirements of 21 CFR Part 11 regulations. DeNovix software enables a method of compliance, but organizations are responsible for establishing and following procedures to ensure compliance.

App Structure

User accounts are listed in the left pane of the screen. Within a user’s own account, tabs in the right pane allow access to User Profile, Emails, Network Folders and Default settings.

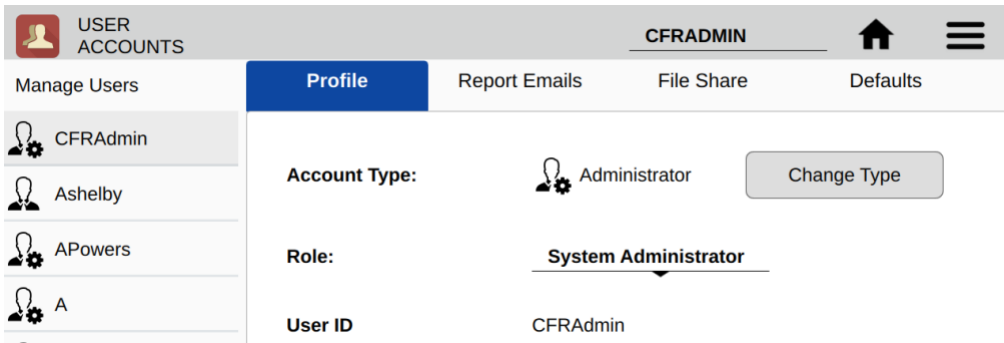

Administrators can access the Profile tab of other users by selecting that user from the list in the left pane.

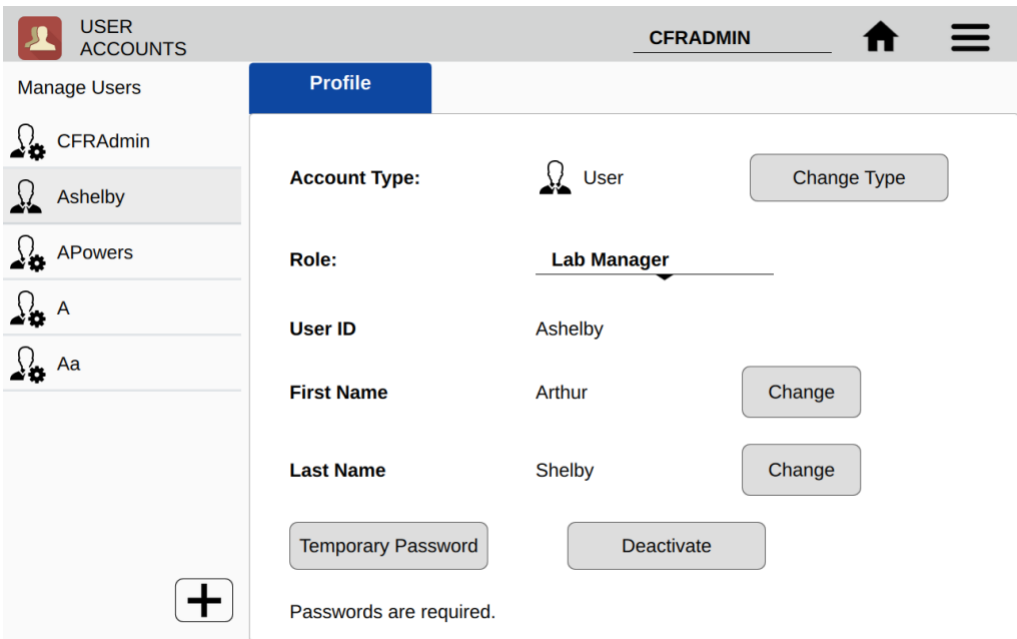

App Functions

Administrators have the following functions within the User Accounts app.

- Add accounts
- Set Account Type
- Assign Role
- Change first name or last name
- Set Temporary Passwords
- Deactivate / Reactivate accounts

Adding Accounts

Choose the + symbol from the left column to add a new user. Assign a User ID and the user's information. Create a temporary password for the new user. All users must have a unique User ID.

Account Type

- User – This account type has full access to count apps and permitted utility apps. User account types do not have any access to Administrator level system settings. A user may change first name, last name or password of his/her own account, but the user cannot change anything related to other user accounts.
- Administrator – This user type has full access and control over all system settings. At least one Administrator account must always be active in 21 CFR Mode. All Administrator accounts have the same administrative controls on the device.

Role

Each user must be assigned to an available Role as defined in the 21 CFR App. See 21 CFR App section for configuration details.

Account Passwords

- Passwords are required for all Users.
- Password must follow the organization rules set in the 21 CFR App (special characters, length, etc.)
- A user may not reuse a password they have previously used.
- If a user is unsuccessful logging in over a set number of times (set in 21 CFR app), the account is locked. An administrator can set a temporary password to unlock the account.
- Organizations are responsible for establishing password security procedures to ensure compliance with 21 CFR Part 11 requirements.
- Contact DeNovix customer support or your local distributor if the sole Administrator password is forgotten. Please have the serial number of the instrument available when requesting help for the reset.

Deactivate / Reactivate an Account

User accounts may be deactivated by an Administrator. Per 21 CFR Part 11 guidelines, a user account may not be deleted. User activation/deactivation is tracked in the Audit Trail.

Tab - Email Addresses

Multiple “to” email addresses for exporting results may be set up for each account. The nickname is used in the drop-down list presented on an export destination dialog box.

Tab - Defaults

Some application specific default settings may be defined on a per account basis. Launch the Accounts app from the Home screen and then use the drop-down menus to select the account, the app and the setting of interest.

Note: The default selections for the General Account may not be modified.

Data App

This app allows the user to search for past data by user, date or application. Data can then be added to the Report and Graph screens for review and export.

Data may be filtered in the following ways from within the 21 CFR software:

- App, Export status, User ID, Signature Type, date
- Once the filter criteria have been selected, tap the **Search** button at the bottom of the screen. Tap any column header to sort the results list.
- Highlight the sample(s) of interest and tap the **Add to Report** button to include the samples on Results tab pages.

- All data must be from the same app type for the samples to be added to the Report tab.
- Features and functions previously described for the Result screens apply to the corresponding Data App Report screens.

Export

All data is automatically saved to the onboard memory at the time of measurement and may be exported as described in the previous section.

When the export function is used data is not deleted.

Delete

The Delete function is not active for instruments in 21 CFR Mode. Data can only be archived from the system by an Administrator through the 21 CFR app.

Settings App

See Settings App section in Utility Apps and Functions.

Updater App

This app can be opened by Administrator level user accounts when in 21 CFR Mode. Updater is used to update system software and firmware to the most current available versions. Updates may be downloaded using the Updater app when connected to Ethernet or Wi-Fi. An Ethernet connection is recommended for software updates.

Updates may also be downloaded to a FAT32 formatted USB drive from denovix.com. Download the update file to the root directly of the USB drive. Do not change the file name. Insert the USB drive in the device and then launch the Updater app. Follow the onscreen instructions to update.

Note: The update process may require one or more automatic system reboots.

13. Lab Tool Apps



Calculators



Timer



ScreenLocker

Calculator App

Three calculators are included within the app. Use the tabs in the top action bar to navigate between the options.

Oligo Calculator

This calculator analyzes a user input ssDNA or RNA sequence of interest.

- *Outputs include:*
 - *Length*
 - *Molecular Weight (g/mol)*
 - *GC Content*
 - *Mass Extinction Coefficient ($\mu\text{g}/\text{OD}$ @260 nm): This result may be copied and pasted into the Factor Input field used for nucleic acid concentration calculations in both the ssDNA and the Microarray apps.*
 - *Melting Temp: For sequences up to 13 nucleotides, the equation used is $T_m = (wA+xT) * 2 + (yG+zC) * 4$ where w,x,y,z are the number of the bases A,T,G,C in the sequence. For sequences longer than 13 nucleotides, the equation used is $T_m = 64.9 + 41 * (yG+zC - 16.4) / (wA+xT+yG+zC)$. Both equations assume that the annealing occurs under the standard conditions of 50 nM primer, 50 mM Na+, and pH 7.0.*

Scientific Calculator

Use this calculator for standard mathematical and scientific functions.

Dilution Calculator

This calculator is a useful tool to calculate how much of a stock solution should be added to a buffer solution to result in a final specified solution concentration.

- Both molar and mass units are available. However, conversions between the two types of units are not enabled.

Timer App

This app is a lab tool that allows a user to set two independent timers.

- At the end of a specified period, an alarm will sound.
- Push the **Off** button to silence the alarm.
- The Timer will work in the background while other measurement apps are in use as well as when the screen is in the dark screen saver mode.

ScreenLocker

Launch the ScreenLocker app from the Home screen prior to cleaning the touch screen. This will disable swiping motions from activating other software activities. Tap the home button to exit.

14. Maintenance

Guidelines

- Use only a dry, soft, lint-free cloth to clean the front screen.
- Do not use a spray bottle to apply water or any other solutions onto any surface of the instrument as the liquid may damage internal components.
- Hint: Launch the ScreenLocker app prior to cleaning the touch screen to prevent swiping motions from activating other software activities.

Fluorescence Mode Holder Cleaning

The sample tube holder may be cleaned of excess dust using a damp (not wet) lint free cotton swab.

- Do not allow any liquid to drip into the holders as it may damage the internal components of the instrument.

15. Diagnostics



FX Diagnostics

FX Diagnostics

The FX diagnostics feature is available in all QFX units.

Procedure

1. Ensure FX sample measurement tube holder is empty and the lid is closed
2. Launch the **FX Diagnostics** app and push the **Start** button.
 - Follow the on-screen instructions regarding tube insertion and orientation.
 - The software tests that each LED is firing and each detector is functioning properly. Results will be reported as Pass/Fail.

16. Troubleshooting

Fluorescence Mode

- Use 200 μ L volumes in a clear thin-walled PCR tube
- Avoid introducing air bubbles into the sample solution when mixing samples.
- Ensure all sample concentrations in the thin-walled assay tubes fall within the limits of the assay or reagent kit for accurate results.
- Follow assay reagent manufacturers' recommendations regarding temperature, incubation time, and protection from ambient light.
- Follow assay reagent manufacturers' recommendations regarding suggested standard curve concentrations and data analysis.
- Confirm that the correct LED excitation source was used.
- Confirm that standard concentrations and dilutions were prepared correctly.
- Confirm that the correct concentration units for the standard curve and the unknown samples were used to calculate the stock concentrations.
- Ensure that the correct optional dilution factor (or μ L added in the case of Qubit™ and DeNovix assays) is entered into the appropriate Run screen field *before* a measurement is made.
- Ensure all samples and standards are treated identically in terms of incubation times and temperature.
- Minimize assay tube and solution temperature fluctuations as these may impact the accuracy of the measurement.
- Do not label the side of an assay tube as this could interfere with the sample measurement.

Additional troubleshooting resources (technical notes and FAQ's) are available at our website.

Software Errors

Pop-up messages will provide guidance for software-based errors or invalid user actions. In most cases, simply relaunching the app or restarting the instrument will allow the user to continue to make measurements. Update the software using the **Updater** app if experiencing a reoccurring software error.

Printer and Barcode Scanner

The QFX is compatible with selected label printers* and Opticon OPI 3601 USB barcode scanners. For accessory product troubleshooting and warranty information, please contact the manufacturer of the product. DeNovix support is limited to the specific use of the product with a QFX instrument.

*Please refer to our website for a list of supported label printers.

17. Customer Support

DeNovix Inc.
3411 Silverside Road, Hanby Building
Wilmington, DE USA 19810
302-442-6911
info@denovix.com

Please include the serial number of your instrument when contacting Customer Support by email. If sending Customer Support a Screen Capture or a report .csv file using the QFX email feature, include your name, institute/company, phone number and return email address. **Please note responses will not be sent directly to the email account used by the instrument.**

From the Diagnostics App use the overflow menu to access the TechSupport file package. Include those files, when possible, with a request for support.

Outside of the US, please contact your local distributor for assistance.

Warranty

All product(s) and accessories sold by DeNovix Inc. are under warranty against manufacturing defects in parts.

Disclaimer

All information in this document is for reference purposes only. DeNovix Inc. makes no claims that this document is complete or error-free and assumes no responsibility and will not be liable for any errors, omissions, damage or loss that might result from any use of this document. The information in this document is updated frequently and may be updated at any time. Visit denovix.com to obtain the latest version.

Instructions for Disposal of Packaging and Waste Equipment

DeNovix encourages customers to locally recycle shipping and packaging materials. Corrugated cardboard and paper can be recycled wherever it is accepted locally (e.g., curbside bins, recycling facilities, etc.). For foam and plastics, please contact your local recycling office for information on how to recycle.

When an instrument has reached its end of life, DeNovix recommends that customers responsibly dispose of the equipment by following in line with local regulations. Material construction is available upon request. Visit denovix.com/sustainability for more information.

Research Use Only

DeNovix Inc. products are for research use only.

Qubit, Quant-iT, PicoGreen and OliGreen are trademarks of Thermo Fisher Scientific and its subsidiaries. QuantiFluor is a trademark of Promega Corporation.